

Scanners and Accessories



- Manual Scanners
- Motorized Scanners
- Accessories

The Company

The Olympus Corporation is an international company operating in industrial, medical, and consumer markets, and specializing in optics, electronics, and precision engineering. Olympus instruments contribute to the quality of various products and add to the safety of infrastructure and facilities.

Olympus is a world-leading manufacturer of innovative nondestructive testing and measurement instruments that are used in industrial and research applications ranging from aerospace, power generation, petrochemical, civil infrastructure, automotive and consumer products. Leading-edge testing technologies include ultrasound, ultrasound phased array, eddy current, eddy current array, microscopy, optical metrology, and X-ray fluorescence. Olympus products include flaw detectors, thickness gages, industrial NDT systems and scanners, videoscopes, borescopes, high-speed video cameras, microscopes, probes, and various accessories.

Olympus NDT is based in Waltham, Massachusetts, USA, and has sales and service centers in all principal industrial locations worldwide.

Visit www.olympus-ims.com for applications and sales assistance.



Scanners are usually not supplied with probes and wedges. For phased array probes and wedges, refer to the Phased Array Probes and Wedges catalog; for UT probes and wedges, refer to the Ultrasonic Transducers catalog.



Table of Contents

Scanners

Scanner Technical Matrix	4
Scanner Application Matrix	4
Manual One-Axis Scanner	5
Mini-Wheel – Small Footprint Encoder	5
HST-X04 – TOFD Weld Inspection	6
VersaMOUSE – Manual One-Line Indexer Scanner	7
RollerFORM – Phased Array Wheel Probe	8
HydroFORM/RexoFORM – Corrosion Mapping	10
COBRA – Weld Inspection of Small-Diameter Pipes	12
HST-Lite – TOFD Weld Inspection	14
HSMT-Compact – Weld Inspection	15
HSMT-Flex – Weld Inspection	16
HSMT-X03 – Weld Inspection	17
Motorized One-Axis Scanner	18
WeldROVER – Weld Inspection	18
Manual Two-Axis Scanner	20
CHAIN Scanner - Pipe Inspection	20
GLIDER – Composites Inspection	22
WING Scanner – Composite Inspection of Curved Surfaces	24

Accessories

Couplant-Feed Units	25
CFU03 and CFU05 – Electric Couplant-Feed Units	25
Manual Couplant-Feed Units	25
Pulsers and Preamplifiers	26
TRPP 5810 – Pulsar/Preamplifier for TOFD Inspection	26
5682 – Preamplifier for TOFD Inspection	27
PR-06-04 – Pulsar/Preamplifier for Pulse-Echo Inspection	27
Cables and Adaptors	28
Umbilical Cables	28
Adaptors and Extension Cables	29
Interbox	30
Yokes	31
Aqualene Elastomer Couplant	31



Scanners and Accessories

An important aspect influencing inspection quality is the capacity to precisely position probes according to the surface being inspected. Depending on the application, various constraints can occur that can make probe positioning difficult. Olympus offers a wide range of industrial scanners and accessories to assist inspectors in their work while providing optimal data acquisition. Some of the applications covered by our scanner product line are: weld inspection, corrosion mapping, and aerospace. Supported technologies include: phased array, conventional ultrasonic, TOFD, eddy current and eddy current array. Scanner configurations can be of various types: one or two encoded axes, in addition to manual or motorized motion.

Scanner Technical Matrix

Inspection Technology	One-Axis Scanner		X-Y Scanner
	Manual	Motorized	Manual
Conventional ultrasonics	HSMT-Compact™ HSMT-Flex™ HSMT-X03™ HST-X04™	WeldROVER™	CHAIN™ Scanner GLIDER™ WING™ Scanner
TOFD	HST-X04 HST-Lite HSMT-Compact HSMT-Flex HSMT-X03	WeldROVER	CHAIN Scanner
Phased array	Mini-Wheel™ VersaMOUSE™ RollerFORM HydroFORM™/RexoFORM™ COBRA™ HSMT-Compact HSMT-Flex HSMT-X03	WeldROVER	Mini-Wheel + Indexer-Clicker VersaMOUSE RollerFORM CHAIN Scanner HydroFORM + CHAIN Scanner GLIDER WING Scanner
Phased array and TOFD	HSMT-Compact HSMT-Flex HSMT-X03	WeldROVER	CHAIN Scanner

Scanner Application Matrix

Scanner Model	Weld	Corrosion	Aerospace
Mini-Wheel	✓	✓	✓
VersaMOUSE	✓	✓	✓
RollerFORM			✓
HydroFORM/RexoFORM		✓	
COBRA	✓		
HST-X04	✓		
HST-Lite	✓		
HSMT-Compact	✓		
HSMT-Flex	✓		
HSMT-X03	✓		
WeldROVER	✓		
CHAIN Scanner	✓	✓	
GLIDER		✓	✓
WING Scanner		✓	✓

Scanner Encoder Connector Compatibility

Except when stated differently, scanners sold after July 2013 come standard with the LEMO connector compatible with the OmniScan MX2 and SX instruments. For use on a different instrument, an optional adaptor is required.

Required Encoder Cable Adaptor

Scanner Connector	Instrument			
	OmniScan MX	OmniScan MX2	OmniScan SX	Tomoscan Focus LT
LEMO (From 07/2013)	Omni-A-ADP27 [U8780329]	N.A.	N.A.	C1-LF-BXM-0.3M [U8769010]
DE15 (Prior to 07/2013)	N.A.	Omni-A2-ADP20 [U8775201]	Omni-A2-ADP20 [U8775201]	C1-DE15F-BXM-0.30M [U8767107]

Manual One-Axis Scanner

Mini-Wheel – Small Footprint Encoder

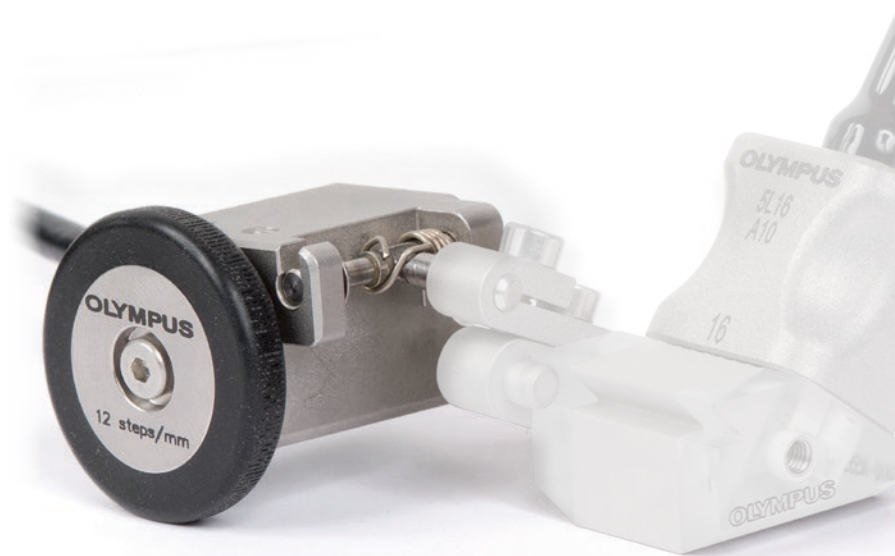

The Mini-Wheel™ encoder is used for the positioning and dimensioning of defects in the scan axis, and can synchronize data acquisition with probe movement. Typical applications are: laboratory testing, training, and manual inspection data sampling*.

The Mini-Wheel encoder is waterproof and compatible with the HST-X04 scanner, in addition to standard Olympus PA wedges, on which it can be mounted using the included bracket kit. This miniature encoder is made entirely of stainless steel, and features sealed bearings for long-lasting smooth operation. The custom electronic circuit was designed to prevent noise induction in UT signals.

Specifications

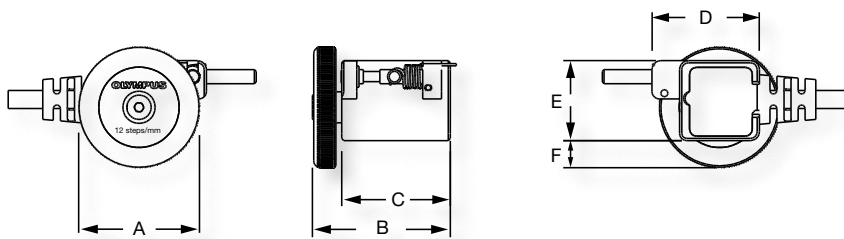

A = 27 mm (1.1 in.)

B = 31 mm (1.2 in.)

C = 24.5 mm (0.96 in.)

D = 24.2 mm (0.95 in.)

E = 18 mm (0.71 in.)

F = 6.1 mm (0.24 in.)

Ordering Information

Part Number	Item Number	Connector	Compatibility
ENC1-2.5-LM	U8775295	LEMO	OmniScan MX2 and SX
ENC1-2.5-DE	U8780197	DE-15	OmniScan MX
ENC1-2.5-BX	U8780196	Bendix	TomoScan Focus LT

The cable length suggested in the table is 2.5m. Other length are available.

Features

- Waterproof (IP68).
- Stainless steel construction.
- Minimal noise induction.
- Small dimensions.
- Encoder resolution is engraved on the wheel (12 steps/mm).
- Removable encoder wheel.
- Overmold rubber friction wheel for better adherence.
- Sealed bearing for long-lasting smooth wheel rotation.
- Spring-loaded pin for adaptable encoder attachment.
- Two M3 threaded holes on top of the casing for custom attachment.

Standard Inclusions

- One encoder with standard rubber wheel.
- One mounting bracket kit.
- One hexagonal screwdriver for bracket attachment.

Options

Magnetic Wheel

For maximum adherence of the wheel on ferromagnetic surfaces, magnetic wheels are available. The first is compatible with the O-ring tire encoder and the V2 is for the overmold tire encoder.

P/N: ENC1-A-MagWheel [U8902964]
ENC1-A-MagWheel-V2 [U8775290]

Mounting Bracket Kit

An extra mounting bracket kit to mount the Mini-Wheel encoder on a wedge.

P/N: ENC1-BRACK [U8775120]

Indexer Clicker

The kit includes a clicker button that sends the indexing signal required for two-axis inspections. In addition, a 3-to-1 splitter cable connects the encoder, clicker button and an optional digital input source (DIN) to the OmniScan.

All connectors are DE-15 type. Use of Omni-A2-ADP20 and/or Omni-A-ADP27 may be required for compatibility with Lemo scanners and/or Instruments.

P/N: OPTX674 [U8775015]

*For high-rate inspection, use of a scanner with heavy-duty encoding devices is recommended.

Manual One-Axis Scanner

HST-X04 – TOFD Weld Inspection



The HST-X04™ time-of-flight diffraction (TOFD) manual scanner offers an efficient, low-cost weld inspection solution. The HST-X04 operates either on flat surfaces, or on pipes as small as 50 mm (2 in.) OD. Typical applications are: laboratory testing, training, and manual inspection data sampling*.

Options

Pre-amplifier

5682 pre-amplifier. See the accessories section on page 26.

Specifications

Frame Bar Length (mm)	Length in Scan Axis (mm)	Width (mm)	Height (mm)
150	60	190	50
250	60	290	50

Ordering Informations

Part Number	Item Number	Description
HST-X04	U8750007	Standard kit (see standard inclusions).
HST-X04-SCN	U8779098	Scanner and Mini-Wheel encoder only (no probes, wedges, or cables).
HST-X04-PA	U8775137	Scanner holds 40 mm wide phased array wedges, and a Mini-Wheel encoder (no probes, wedges, or cables).

Features

- Encoded linear scan (one axis) for TOFD or pulse-echo inspections with appropriate yoke.
- A waterproof, spring-loaded encoder with a rubber wheel for maximum adherence on inspected surfaces.
- The encoder has a resolution of 12 steps/mm, and can be positioned parallel to the weld, or at a 90° skew.
- Compact, light, and versatile.
- Cost-effective.
- Fits a full range of probes and wedges, including the CentraScan™ composite product line (wedges must be 31.75 mm wide).
- Probe-center separation (PCS) is fully adjustable from 17 mm to 180 mm.
- A low-profile frame for use in limited-access areas where minimal clearance is required.
- Quick, tool-free release of wedges and probe holders.

Standard Inclusions

- Scanner with a 150 mm frame, and a supplementary 250 mm frame for wider probe center separation.
- Two 10 MHz (3 mm element diameter) CentraScan™ composite TOFD probes, plus two 5 MHz (6 mm element diameter) CentraScan™ composite TOFD probes.
- Three pairs of ST1 wedges with carbide wear pins and irrigation holes for 45°, 60°, and 70° inspection.
- Two 2.5 m LEMO 00 to Microdot transducer cables.
- 2 LEMO 00 to BNC adaptors.
- A spring-loaded, friction-driven, and waterproof Mini-Wheel™ encoder for X-axis or Y-axis data encoding (see page 5 for details).
- Brackets for flexible encoder positioning.
- A carrying case.

*For high-rate inspection, use of a scanner with heavy-duty encoding devices is recommended.

VersaMOUSE – Manual One-Line Indexer Scanner

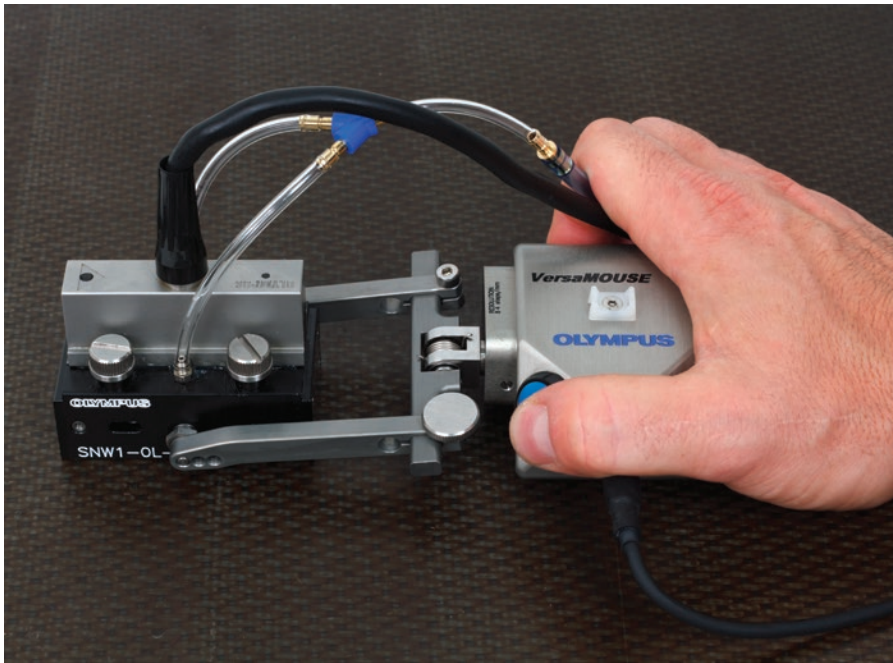

The VersaMOUSE™ is a scanner designed for linear encoded scans with a phased array probe. The integrated indexing button makes it ideal for 2-D mapping applications such as CFRP flat panel and corrosion inspections. The VersaMOUSE can perform an encoded one-line scan, followed by indexing of the position in the perpendicular direction. Another one-line scan can then be performed and juxtaposed to the previous scan. This process is repeated to produce a complete 2-D map of the area of interest.

The exclusive adjustable yoke of the VersaMOUSE is easy to set up on an IHC-type wedge using standard attachment holes. The spring-loaded system is optimized to offer the lowest clearance possible. The yoke is also attached to the scanner using a quick-connect system, which keeps the probe either parallel or at a 90° skew to the scan axis.

The encoder wheels are specially designed to resist slippage on wet surfaces. The rugged construction makes this scanner an affordable, yet reliable solution for all phased array inspections performed with a single probe. For even better stability on ferromagnetic surfaces, an optional magnetic wheel package is available.

Specifications

Probe-Holder Position	Length in Scan Axis (mm)	Width (mm)	Height (mm)	Weight (kg)
Front	170	80	42	0.4
Side	80	152	42	0.4



An easily clipped and spring-loaded yoke that can be positioned with a 90° skew.

Features

- Encoded linear scan (one axis) for phased array inspection.
- Integrated clicker button for indexing enabling 2-D mapping.
- Adjustable fork for easy and fast installation of multiple wedge dimensions.
- Two rubber wheels that remain in contact with the surface for maximum adherence.
- An easily clipped and spring-loaded yoke that can be positioned with a 90° skew.
- Encoder resolution: 8.4 steps/mm.
- Durable aluminum body and waterproof construction.

Standard inclusions

- 2.5 m encoder cable.
- One adjustable PA yoke (width: 65 mm, length: 65 mm).
- A carrying case.

Note: Probes and wedges are not included with the scanner.

Options

Magnetic Wheels package

For maximum adherence of the wheels on ferromagnetic surfaces, in addition to improved stability.

P/N: VersaMOUSE-A-MagWheel [U8775247]



VersaMOUSE scanner and RexoFORM for corrosion inspection.

RollerFORM – Phased Array Wheel Probe



Features

- Exceptional coupling, requiring minimal couplant.
- Acoustic impedance similar to water.
- 25 mm water delay line enables inspection of composites up to 50 mm thick.
- Up to 51.2 mm wide beam coverage.
- Can be used in accordance with existing aircraft manufacturer procedures.

Standard Inclusions

- Phased array probe with OmniScan connector.
- Waterproof encoder with OmniScan MX2 or SX compatible connector.
- Laser guide.
- Indexer and Start Acquisition buttons.
- Spare parts.
- Filling/spraying pump and tubing.

Olympus introduces the RollerFORM™, a new phased array wheel probe designed to address the inspection of composites and other smooth-surfaced materials, such as those commonly used by the aerospace industry. An affordable and easy-to-implement replacement for full 2-D encoding systems, the RollerFORM also offers a viable alternative to immersion techniques.

The unique tire material of the RollerFORM has been specifically developed to guarantee high-quality, immersion-like ultrasonic testing. Minimal couplant and pressure is required for the RollerFORM to provide excellent coupling and a strong signal, even in difficult scanning positions.

Just Roll It for Instant Results

The RollerFORM, combined with a phased array instrument such as an OmniScan® or the FOCUS™ LT, uses zero-degree ultrasonic beams for manufacturing and maintenance inspections. Common applications include delamination sizing and porosity quantification in composite core material, as well as wall-loss monitoring in aluminum panels. With its integrated indexing button, the ergonomically designed RollerFORM enables you to map the surface of an inspected material by acquiring multiple one-line C-scans and combining them in real time into a single image. The built-in laser guide facilitates straight and precise one-line scans.

In addition to providing exceptional coupling, the tire of the RollerFORM wheel is made of a unique material that closely matches the acoustic impedance of water. This design feature permits the efficient transmission of energy to the part without unwanted echoes, obtaining an optimum 1 mm near-surface resolution in composites when using the 5 MHz phased array probe model. The 3.5 MHz phased array probe model is better suited for certain thicker, more attenuating materials. Since the tire is transparent, you can easily identify the presence of air bubbles or contaminants within the water chamber.

Specifications

Description	Value
Typical Near Surface Resolution (3 x 3 mm delamination)	1 mm at 5 MHz 1.5 mm at 3.5 MHz
Position of Repeat Interface Echo (in composite)	50 mm
Minimum Surface Curvature (convex radius)	50 mm
Dimensions (L x W x H)	235 x 145 x 150 mm
Weight (without water)	1.5 kg

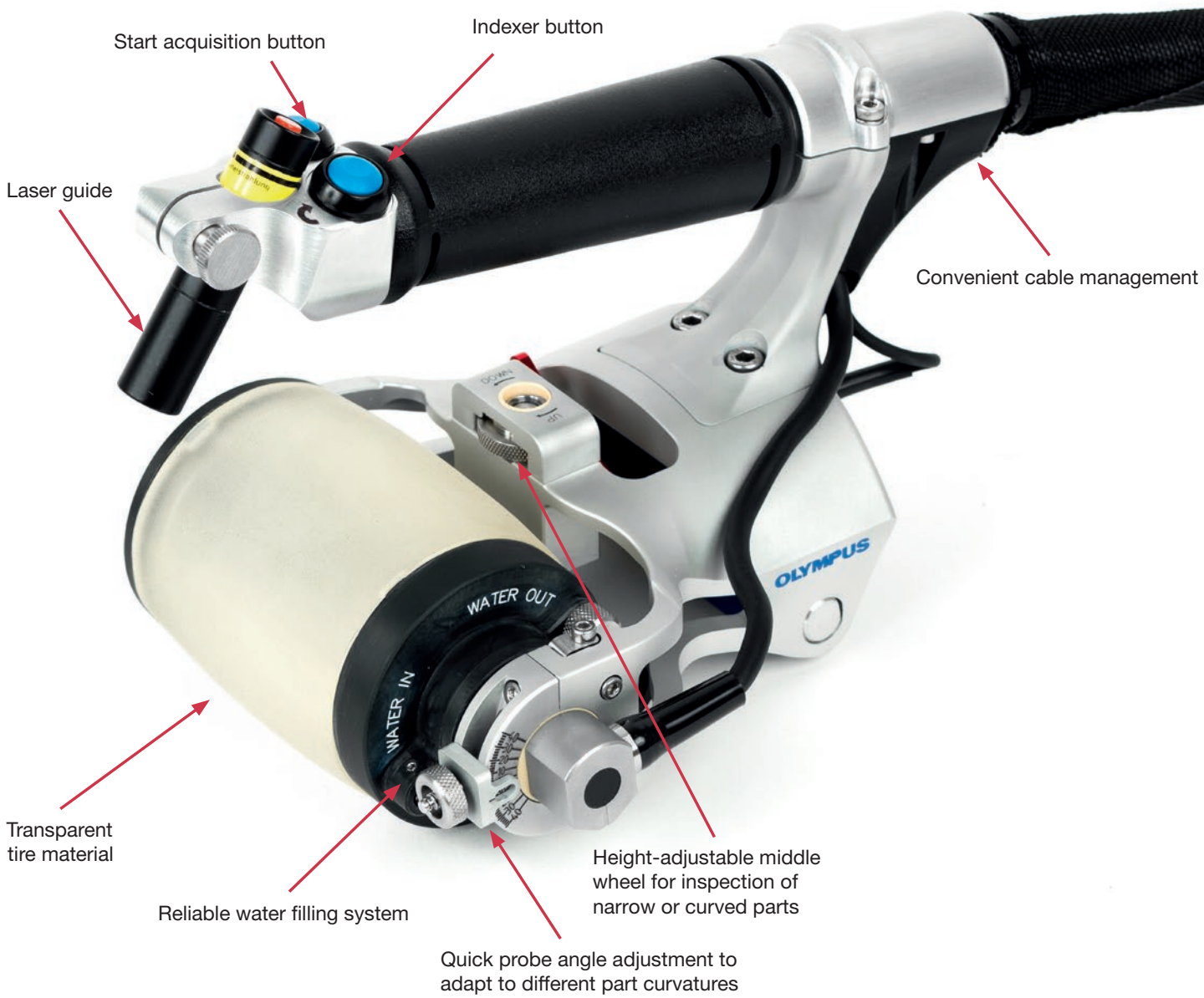

Ordering Information

Part Number	Item Number	Frequency (MHz)	Delay Line Height (mm)	Number of Elements	Pitch (mm)	Active Aperture (mm)	Elevation (mm)	Probe Casing Model	Cable Length (m)
RollerFORM-3.5L64	U8775334	3.5	25	64	0.8	51.2	6.4	IWP1	2.5
RollerFORM-5L64	U8775335	5	25	64	0.8	51.2	6.4	IWP1	2.5
RollerFORM-3.5L64-5M	U8778683	3.5	25	64	0.8	51.2	6.4	IWP1	5
RollerFORM-5L64-5M	U8778684	5	25	64	0.8	51.2	6.4	IWP1	5

HydroFORM/RexoFORM – Corrosion Mapping



The HydroFORM and RexoFORM are designed to offer the best inspection solution for the detection of wall-thickness reductions due to corrosion, abrasion, and erosion. Our solution also detects mid-wall damage such as hydrogen-induced blistering or manufacturing-induced laminations, and easily differentiates these anomalies from loss of wall thickness.

The unique quick adjustment device offered by both scanners allows the wedge/probe assembly to be positioned to any curvature greater than 4 in. OD (101 mm).

Specification Comparison

	HydroFORM	RexoFORM
Phased array probe	I4	A12, A14
Maximum one-line scan coverage (width)	60 mm	38 mm (A12), 60 mm (A14)
Delay line medium	Water	Rexolite
Delay line height	14 mm or 24 mm	20 mm
Position of repeat interface echo (in steel)	125 mm	50 mm
Typical near-surface resolution ($\frac{1}{8}$ in. FBH)	1.5 mm	2 mm
Depth resolution	0.1 mm	0.1 mm
OD inspection range	4 in. and greater	4 in. and greater
ID inspection range	10 in. and greater	N/A
Contact device	Wheels	Carbides
Footprint	110 mm x 130 mm	40 mm x 95 mm
Scan direction	Circumferential	Circumferential
Scan speed (1 mm x 1 mm resolution)	100 mm/s	100 mm/s
Scanner compatibility	CHAIN Scanner	CHAIN Scanner, GLIDER, and VersaMOUSE

Features

- The first commercially-available, semi-automated phased array product for corrosion mapping applications.
 - Reduced probe raster movement increases safety for operators, and improves mechanical reliability.
- The patent-pending quick radius adjustment allows for the inspection of different curvatures. No wedges are needed.
 - Convex surface: 4 in. OD, up to flat.
 - Concave surface: 10 in. ID, up to flat (HydroFORM).
- HydroFORM and RexoFORM can be attached to automated or semi-automated scanners, and used independently as manual scanners.
- Cost-effective.
- Minimal tools required for normal operation.

Standard Inclusions

The HydroFORM manual corrosion mapping scanner kit includes:

P/N: HYDROFORM-K-MANUAL [U8775182]

- One probe holder with a water delay line
- One carriage with four magnetic wheels
- One phased array probe (7.5L64-I4-P-7.5-OM)
- 100 foam gaskets
- One application-specific Mini-Wheel encoder
- One 7.5 m encoder cable extension
- Irrigation tubing and accessories

The RexoFORM manual corrosion mapping scanner includes:

P/N: REXOFORM [U8775241]

- One probe holder with a Rexolite delay line

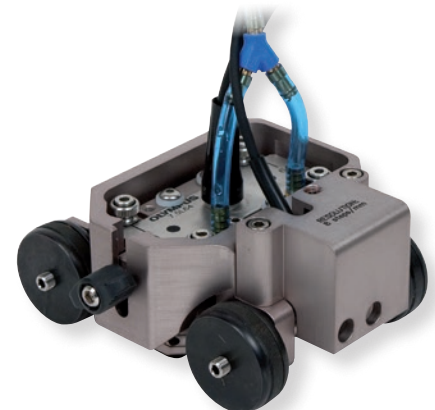

A patent-pending quick radius adjustment enables inspection of different curvatures without the need for wedges. The HydroFORM also has an integrated encoder, which is required for manual inspections.

HydroFORM

High-performance corrosion mapping for rough and uneven surfaces

- Easy gate synchronization with the front wall for backwall corrosion monitoring and remaining wall thickness measurement
- Wedge reflection is eliminated.
- Coupling is optimized.
- Provides excellent near-surface resolution.

HydroFORM utilizes an ingenious water-column concept that eliminates the need for a wedge, thus providing the benefits of a phased array immersion-tank inspection. This concept, which uses a low-flow water supply and consumable gaskets, offers excellent surface conformance and optimized coupling conditions, even on rough surfaces.

By exploiting gate synchronization with the interface echo available in the OmniScan software, the HydroFORM provides optimum near-surface resolution, precision measurements, and an enormous improvement in flaw characterization over conventional UT.



XY mapping principle on pipes with the HydroFORM and CHAIN scanner.

RexoFORM

Quick and easy corrosion mapping for smooth surfaces and limited access areas

- Smaller, lighter, and perfect for limited access areas (rope access).
- Excellent surface coverage.
- Operates without the need for a continuous water supply.
- Affordable complement to the HydroFORM.

The RexoFORM is a new innovative wedge for phased array 0° and angle beam inspection with the Rexolite delay line. With its unique design, the RexoFORM can be used on pipes of different diameters with no need for multiple curved wedges. The RexoFORM is also compatible with the A12 and A14 standard probes, making it an affordable solution.

The RexoFORM is the perfect complement to the HydroFORM. In fact, it is simple, small, and easy to use, even when a continuous water supply is not available, and/or in limited access areas. The RexoFORM is also compatible with Olympus scanners such as the Mini-Wheel, the VersaMOUSE, the CHAIN Scanner, and the GLIDER scanner, to name a few.

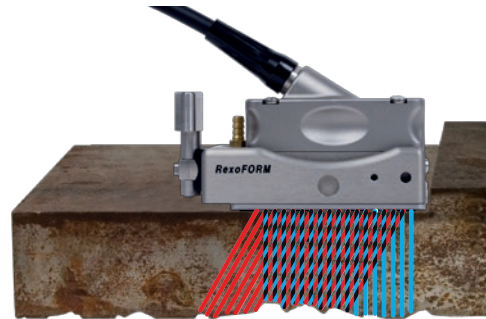

Example of beam possibilities with the RexoFORM and A14 probe.

Ordering Information

Part Number	Item Number	Description	HYDROFORM-K-ADPCHAIN (U8750058)
HYDROFORM			
HYDROFORM-K-MANUAL	U8775182	HydroFORM corrosion mapping scanner kit	✓
HYDROFORM-A-ADPCHAIN	U8775183	Kit for adapting the HydroFORM to the CHAIN Scanner.	✓
HYDROFORM-SCN	U8750059	Same content as the HYDROFORM-K-MANUAL, without the phased array probe.	
CHAINSCAN-XY38	U8750041	Two encoded axes CHAIN Scanner for pipe OD up to 38 in.	
HYDROFORM-A-LITEHOLDER	U8840177	HydroFORM lite holder to mount the HydroFORM on GLIDER scanner using optional ADIX893 (U8775084) yoke.	
CFU03	U8780008	Electric water pump and tubing; 120 V and 220 V.	
HYDROFORM-SP-FOAM	U8775184	100 foam-gasket spare part kit.	
REXOFORM			
REXOFORM	U8775241	The RexoFORM corrosion mapping probe holder with the Rexolite delay line for use with A12 or A14 probes.	
ENC1-5-LM	U8780198	Mini-Wheel encoder, with 5 m long cable compatible with OmniScan MX2 and SX.	
WTR-SPRAYER-8L	U8775001	8 L manual water pump with irrigation tubes and fittings.	
REXOFORM-SP-WEDGE	U8775242	Spare Rexolite delay line and gasket for RexoFORM.	

COBRA – Weld Inspection of Small-Diameter Pipes

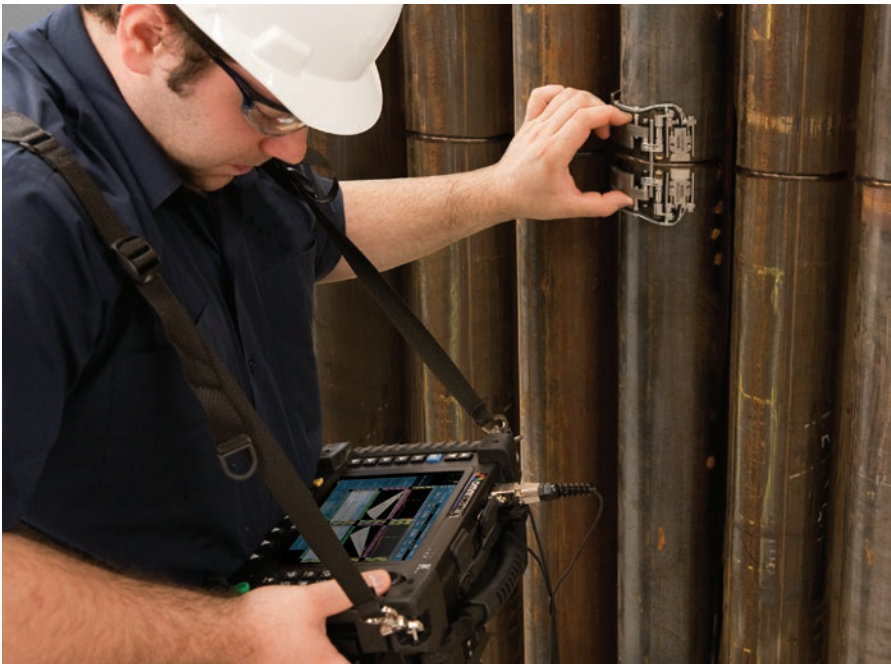

The COBRA™ manual scanner, combined with the OmniScan® PA flaw detector, is used to perform circumferential weld inspections on small-diameter pipes. The COBRA holds up to two PA probes for inspections on pipes with outside diameters ranging from 0.84 in. to 4.5 in.

With its very slim design, this manual scanner inspects pipes in limited access areas where minimal clearance is required. Adjacent obstructions, such as piping, supports, and structures, can be as close as 12 mm (0.5 in.). This spring-loaded scanner is designed to clasp carbon steel and stainless steel pipes of various diameters using multiple link. This unique feature enables the scanner to be installed and operated from one side of a row of pipes. The COBRA scanner is characterized by its smooth-rolling encoded movement, which enables precise data acquisition. The scanner holds up to two phased array probes for complete inspection of the weld in one pass. For pipe-to-component inspections, the scanner can be configured quickly to perform one-sided inspections using a single probe.

This Olympus solution uses low-profile phased array probes with optimized elevation focusing, which enhances detection of small defects in thin-wall pipes. Specially designed low-profile wedges fitting each pipe diameter covered by the scanner are also available for a complete solution.

The COBRA scanner ensures stable, constant, and strong pressure, thus providing good UT signals and precise encoding around the full circumference of the pipe.

Features

- Covers standard pipes from 0.84 in. to 4.5 in. OD (21 mm to 114 mm).
- Operates within 12 mm (0.5 in.) clearance (on all standard pipes), permitting inspections in limited access areas.
- Holds up to two phased array probes for complete weld coverage in one pass.
- Easy installation and manipulation from one side of a row of pipes.
- Can be configured to perform one-sided inspections for pipe-to-component evaluations.
- The included mechanical setup templates eliminate the need for pipe samples when preparing the scanner for standard pipes.
- The design provides stable and constant pressure around the full circumference of the pipe.
- Urethane wheels provide smooth radial movement and limited axial drift.
- Encoder resolution of 32 steps/mm.
- Compact, lightweight, and portable.
- Wedges and probes can be changed quickly and easily.
- The distance between probes can be adjusted from 0 mm to 55 mm.
- The spring-loaded scanner can be used on ferromagnetic and nonferromagnetic pipes.
- Waterproof and rust free.

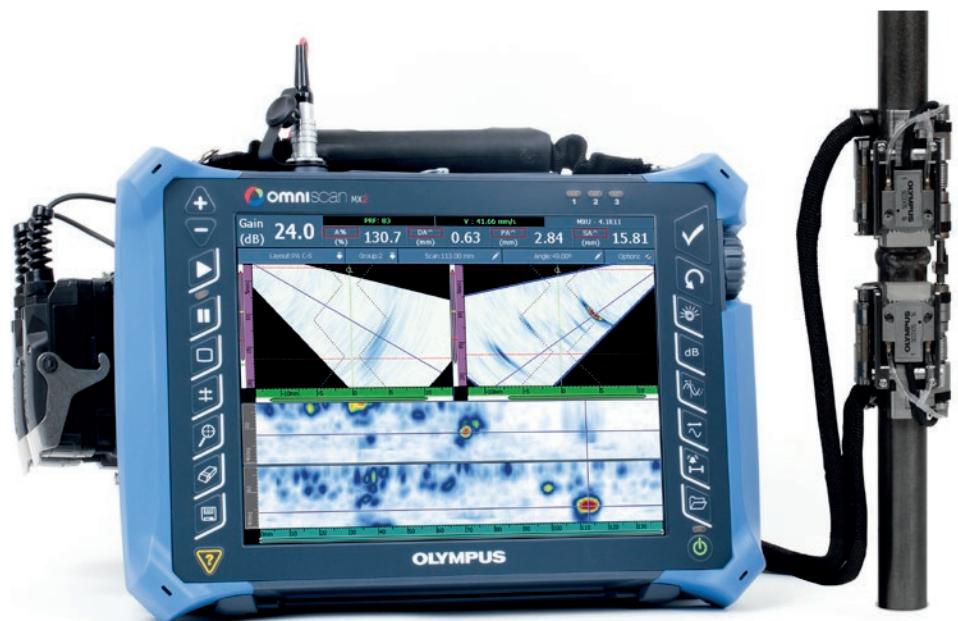

The COBRA scanner on a 0.84 in. pipe with two A15 PA probes with an OmniScan MX2 16:64 displaying two PA groups with sectorial scans, A-scans, and C-scans.

Probes

Part Number	Item Number	Freq. (MHz)	Number of Elements	Pitch (mm)	Elevation (mm)	Elevation Curvature Radius (mm)
2.25CCEV35-A15C-P-2.5-OM*	U8331117	2.5	16	0.5	10	35
3.5CCEV35-A15C-P-2.5-OM*	U8331149	3.5	16	0.5	10	35
5CCEV35-A15-P-2.5-OM	U8331163	5.0	16	0.5	10	35
7.5CCEV35-A15-P-2.5-OM	U8330826	7.5	16	0.5	10	35
10CCEV35-A15-P-2.5-OM	U8331014	10.0	32	0.3	7	35

These probes come standard with an OmniScan® connector and a 2.5 m (8.2 ft) cable.

* A15C casing are based on the same design as the A15 but are 2 mm taller, increasing height clearance.

Wedges

Specially designed SA15 low-profile wedges are available with the different axial outside diameters (AOD) as specified in the table below. These wedges have been optimized to position the A15 probe as close as possible to the weld in order to reduce the number of skips required, and as low as possible for maximum height clearance. This is accomplished with no acoustic compromises. These wedges are fitted with irrigation ports and holes for scanner mounting, and can be configured to generate 60° shear (N60S) or longitudinal (N60L) waves in steel. Wedges for TOFD inspection are also available (use 3 mm diameter element ST1 probes) with the following refracted angles in steel: 60L, 70L, and 80L.

Note: height clearance required for longitudinal wave inspection is 25 mm with SA15, and 35mm with ST1 and right angle cable connector.

Standard Wedge AOD values and Pipe OD

AOD (in.)	Minimum OD (in.)	Maximum OD (in.)
0.84	0.800	0.840
1.05	0.840	1.050
1.315	1.050	1.315
1.66	1.315	1.660
1.9	1.660	1.900
2.375	1.900	2.375
2.875	2.375	2.875
3.5	2.875	3.500
4.0	3.500	4.000
4.5	4.000	4.500



The solution uses low-profile phased array probes with optimized elevation focusing, which improves the detection of small defects in thin-wall pipes.



Wedges for TOFD inspection are also available

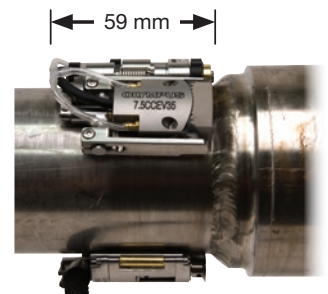

The COBRA scanner can also be configured for pipe-to-component weld inspections.

Ordering Information

Part Number	Item number	Description	Package PN: COBRA-K-4.5 (U8750055)
COBRA	U8750053	Small pipe scanner kit with encoder for coverage of 0.84 in. to 4.5 in. OD standard pipes; packaged in hard carrying case	✓
7.5CCEV35-A15-P-2.5-OM	U8330826	Low-profile phased array probe (16 elements, 7.5 MHz)	✓ (x2)
COBRA-A-SA15	U8721205	2 flat SW wedges, plus 10 pairs of curved SW wedges for pipes of 0.84 in. to 4.5 in. OD	✓
COBRA-A-SA15LW	U8722168	2 flat LW wedges, plus 10 pairs of curved LW wedges for pipes of 0.84 in. to 4.5 in. OD	
COBRA-A-ST1-70L	U8701348	2 flat wedges, plus 9 pairs of curved TOFD wedges for pipes of 1.05 in. to 4.5 in. OD	
COBRA-SP-BASIC	U8775166	Basic spare parts kit	
COBRA-SP-FULL	U8775188	Basic spare parts kit, plus links and the encoder assembly	
COBRA-SP-SA15	U8750056	One of each of the 11 wedges needed for coverage of 0.84 in. to 4.5 in. OD pipes	
OMNI-A2-SPLIT128	U8100133	Y-adaptor (splitter) to support 2 phased array probes on OmniScan MX2 instruments with PA2 128 elements module.	
OMNI-A2-SPLIT64	U8100135	Y-adaptor (splitter) to support 2 phased array probes on OmniScan MX2 instruments with PA2 64 elements module.	
OMNI-A-ADP05	U8767016	Y-adaptor (splitter) to support 2 phased array probes on OmniScan MX instruments	
E128P0-0000-OM	U8800428	Phased array cable extensions required to interface between the Omni-A-ADP05 and an OmniScan MX2 instrument with PA1 128 elements module.	
EIB64-NT-0-P-0-OM	U8779452	Interbox to support 2 phased array probes on OmniScan MX2 instruments with PA1 64 elements module.	
WTR-SPRAYER-4L	U8775153	4 L manual water pump with irrigation tubes and fittings	

HST-Lite – TOFD Weld Inspection

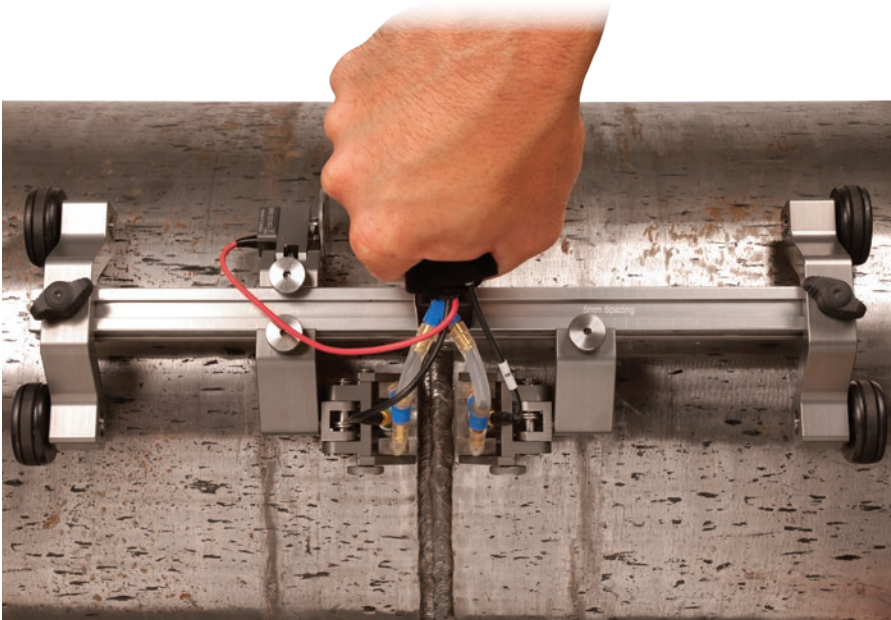

The new HST-Lite scanner is the perfect choice for cost-effective, one-channel TOFD inspections when signal quality is important. The combination of magnetic wheels and spring-loaded probe holders offer the stability required to perform high quality, one-line inspections. The scanner can be operated using only one hand, and will attach to ferromagnetic surfaces even when in an upside-down position.

The scanner's position can be encoded around the circumference of pipes as small as 4.5 in. (114.3 mm) OD, as well as on flat surfaces. Adjustment of the different scanner components can be performed without tools.

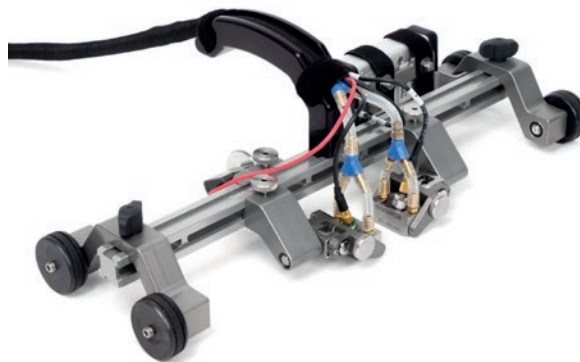

Ordering Information

Part Number	Item Number	Description
HST-Lite	U8750061	Scanner (see standard inclusions).
HST-Lite-kit01	U8750062	Package includes: Scanner 2x 10 MHz, 3 mm TOFD probes 2x 5 MHz, 6 mm TOFD probes 2x ST1-45L-IHS 2x ST1-60L-IHS 2x ST1-70L-IHS 2x 5 m LEMO 00 to Microdot UT cables 2x LEMO 00 to BNC adaptors

Features

- Circumferential scans performed with two TOFD probes on pipes 4.5 in. (114.3 mm) OD, or greater.
- Four magnetic wheels firmly attach the unit to ferromagnetic inspection surfaces.
- Light aluminum frame.
- Independently positioned and spring-loaded probe holders.
- Waterproof, spring-loaded encoder with 9 step/mm resolution.
- Removable handle for lower profile.
- Attachment devices for umbilical cables.
- The frame design enables probes to be positioned outside the wheels (2 additional magnetic wheels are required).
- Engraved references on the scanner and pointer on the probe holders ensure easy probe separation measurement.

Standard Inclusions

- Scanner frame with handle.
- Four magnetic wheels.
- Waterproof, spring-loaded wheel encoder with 5 m cable.
- Two spring-loaded arms (SLA) with TOFD-P/E yokes (31.75 mm wide with 5 mm diameter buttons).
- Irrigation tubing and accessories.
- Cable conduit.
- Carrying case.

Note: Probes and wedges are not included with the scanner.

Specifications

Length in Scan Axis (mm)	Width (mm)	Height (mm)	Weight (kg)
125	385	100*	1,3

*67 mm without handle

Options

Couplant-Feed Units

See the accessories section on page 25.

5682 Remote Preamplifier Kit

P/N: 5682-KIT02 [U8779091]

Magnetic Wheels

P/N: CHAINSCAN-A-MWHEEL [U8779383]

Replacement Encoder

P/N: HST-Lite-SP-ENC [U8775277]

Extra Handle

P/N: HST-Lite-A-Handle [U8775278]

Extra TOFD Probe Holder Kit

P/N: HST-Lite-A-PH-TOFD [U8775279]

HSMT-Compact – Weld Inspection



The HSMT-Compact™ is a manual one-axis encoded scanner designed for maintenance weld inspection. It is particularly small, light, and versatile, and can be used with up to four probes on plates, and for circumferential scans on pipes as small as 4.5 in. (114.3 mm) OD. The scanner width can be adjusted, and the frame can be extended outside the limit of the wheels to provide a configuration that is suitable for hard-to-reach places, such as pipe-to-component welds.

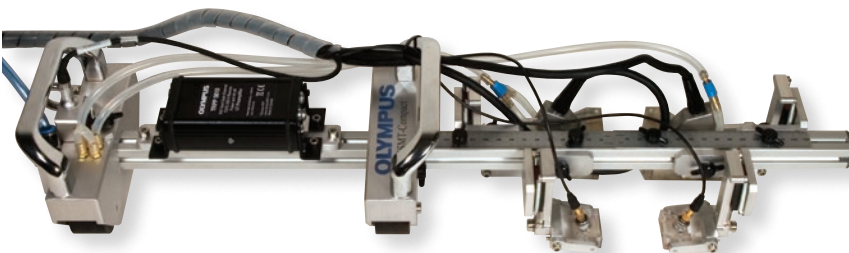

This configuration is suitable for hard-to-reach places such as pipe-to-component welds.

Options

Divisible Cable Conduit

See the accessories section on page 28.

Couplant-Feed Units

See the accessories section on page 25.

Remote Pulser/Pre-amplifier

See the accessories section on page 26.

Extra Probe Holder Kit

Set of two short, spring-loaded arms (SLA) mounted on 90° brackets.

P/N: OPTX0739 [U8779086]

Yokes

See the accessories section on page 31.

Replacement Encoder

P/N: ACIX895 [U8775097]

Spare Parts Kit

P/N: OPTX689 [U8775021]

Features

- Enables circumferential scan using up to four probes (UT or PA) on 4.5 in. (114.3 mm) OD pipes, or greater.
- Four plastic-covered magnetic wheels hold the unit against a ferromagnetic inspection surface.
- Light aluminum frame with customizable width.
- The frame design enables probes to be positioned outside the wheels.
- Independently positioned and spring-loaded probe holders.
- Waterproof, spring-loaded encoder with a 12 steps/mm resolution.
- Removable handles for lower profile.
- Attachment devices for umbilical cables.
- An integrated water manifold that simplifies couplant distribution.
- Metric/US Customary unit rulers on the scanner for easy probe separation measurement.

Standard Inclusions

- Scanner frame with handles, and:
 - 250 mm (10 in.) frame bar
 - 450 mm (18 in.) frame bar
 - 650 mm (26 in.) frame bar
- Four plastic-covered magnetic wheels.
- Waterproof, spring-loaded wheel encoder with a 5 m cable.
- Four 90° probe holder brackets.
- Four spring-loaded arms (SLA).
- Four TOFD-P/E 31.75 mm yokes.
- Two PA 40 mm × 55 mm yokes.
- Irrigation tubing and accessories.
- Cable conduit attachment fixture.
- Carrying case.

Note: the umbilical cable, probes, and wedges are not included with the scanner.

Specifications

Length in Scan Axis (mm)	Width (mm)	Height (mm)	Weight (kg)
152	94 + bar length	102	3.2

HSMT-Flex – Weld Inspection

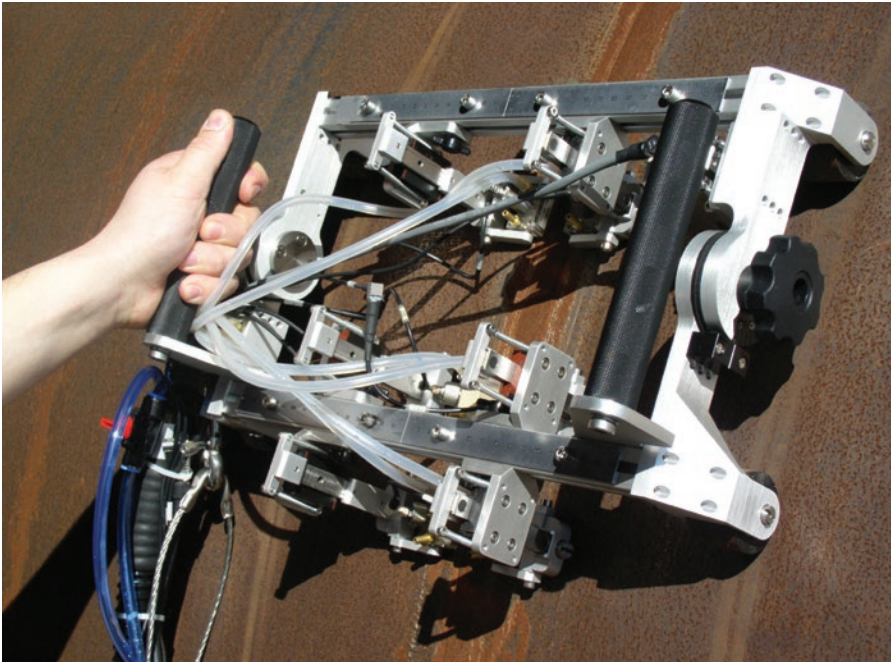

The HSMT-Flex™ is intended for one-axis encoded inspection of circumference welds on pipes of 4.5 in. (114.3 mm) OD, and greater. The scanner comes equipped with four probe holders, but can be mounted with a total of eight probes with optional probe holders. Mounted probes can be either phased array or conventional UT to provide the most efficient inspection results.

The major characteristic of the scanner is its ability to bend in the center. This feature enables the scanner to fit on smaller pipes, and also brings the force of the spring-loaded arm in the radial direction of the pipes for better stability of the wedge and optimum data acquisition. Optional pivoting probe holders can also be installed on the outside of the scanner.

The HSMT-Flex also has one slidable side frame. This feature enables probes to be mounted on the outside of the scanner, providing a configuration that is suitable for hard-to-reach places such as pipe-to-component welds.

Options

Umbilical

See the accessories section on page 28.

Remote Pulser/Preamplifier

See the accessories section on page 26.

Couplant-Feed Units

See the accessories section on page 25.

Laser Guide Kit

Battery-operated laser guiding device for easier weld tracking.

P/N: HSMT-A-Laser [U8779087]

Yokes

See the accessories section on page 31.

Replacement encoder

P/N: ADIX1255 [U8775096]

Probe Holder Kits

Set of two spring-loaded arms (SLA) mounted on 90° brackets to accommodate more than four probes.

Standard: for pipes larger than 12 in. OD.

P/N: OPTX666 [U8775011]

Pivoting: for pipes smaller than 12 in. OD.

P/N: OPTX0717 [U8775095]

Spare Parts Kits

For PV-100 applications

P/N: OPTX686 [U8775020]

For PV-200 applications

P/N: OPTX690 [U8775022]

Features

- A folding frame to optimize probe contact on pipes for circumferential weld inspection.
- Four plastic-covered magnetic wheels which hold the unit against a ferromagnetic inspection surface.
- Compact and versatile. The provided frame bars offer size customization.
- Can support up to four conventional UT or phased array probes on pipes.
- Can support up to eight conventional UT or phased array probes on pipes bigger than 12 in. OD using the optional standard probe holder kit, and on pipes ranging from 4.5 in. to 12 in. OD using the optional pivoting probe holder kit.
- Light aluminum frame.
- Independently positioned, spring-loaded probe holders.
- One waterproof, spring-loaded encoder with a 12 steps/mm resolution.
- Removable handles for a lower profile.
- An eyelet for umbilical attachment.
- An integrated water manifold which simplifies couplant distribution.
- Metric/US Customary unit rulers on the scanner frame for easy probe separation measurement.

Standard Inclusions

- Scanner frame with handles, and:
 - Two 340 mm (13.5 in.) frame bars
 - Two 500 mm (20 in.) frame bars
- Four plastic-covered magnetic wheels.
- One waterproof, spring-loaded wheel encoder with 5 m cable.
- Four 90° probe holder brackets.
- Four spring-loaded arms (SLA).
- Four TOFD-P/E 31.75 mm yokes.
- Two PA 40 mm × 55 mm yokes.
- Irrigation tubing and accessories.

Note: the umbilical cable, probes, and wedges are not included with the scanner.

Specifications

Length in Scan Axis (mm)	Width (mm)	Height (mm)	Weight (kg)
263	466	147	4.4



The hinged design of the HSMT-Flex scanner makes it possible to inspect pipes as small as 4.5 in. OD.

HSMT-X03 – Weld Inspection

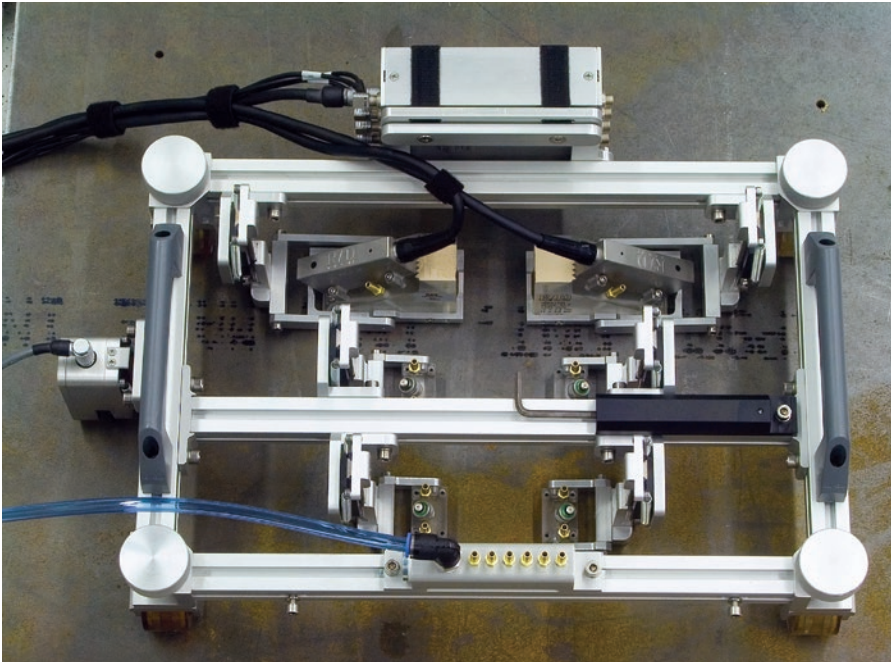

The HSMT-X03™ is the construction weld scanner offering the greatest probe-holding capacity. In fact, the scanner can hold up to 10 probes* for either phased array or conventional UT in order to obtain optimal coverage of the entire weld volume.

Its solid construction guarantees the stability needed for precise data acquisition. The frame width can also be reconfigured to fit restricted spaces using the shorter frame bars supplied.

Options

Umbilical

See the accessories section on page 28.

Remote Pulsar/Preamplifier

See the accessories section on page 26.

Couplant-Feed Units

See the accessories section on page 25.

Laser Guide Kit

Battery-operated, laser guiding device for easier weld tracking.

P/N: HSMT-A-Laser [U8779087]

Yokes

See the accessories section on page 31.

Replacement Encoder

P/N: ADIX1255 [U8775096]

Frame Extensions

A pair of side-mounted frame bars providing greater probe separation for the inspection of thicker welds.

P/N: OPTX684 [U8775019]

Standard Probe Holder Kit

A set of two spring-loaded arms (SLA) mounted on 90° brackets.

P/N: OPTX666 [U8775011]

Spare Parts Kits

For PV-100 applications.

P/N: OPTX686 [U8775020]

For PV-200 applications.

P/N: OPTX690 [U8775022]

Features

- Can support up to 10 phased array or conventional UT probes¹ on pipes of 38 in. (965 mm) OD, and greater.
- The provided frame bars offer size customization.
- Four plastic-covered magnetic wheels that rotate 90° to enable scans in both directions, and hold the unit against a ferromagnetic inspection surface.
- A light, aluminum frame.
- Independently positioned and spring-loaded probe holders.
- A waterproof, spring-loaded encoder with a 12 steps/mm resolution.
- An eyelet for umbilical attachment.
- Metric/US Customary unit rulers on the scanner frame for easy probe-separation measurement.

Standard Inclusions

- Scanner frame with handles, and:
 - Three 300 mm (12 in.) frame bars
 - Two 200 mm (8 in.) frame bars
- Three additional 200 mm (8 in.) frame bars and two additional 125 mm (5 in.) frame bars, allowing smaller footprint configuration, or inspection on pipes with a smaller diameter.
- Four plastic-covered magnetic wheels.
- Four soft rubber wheels.
- One waterproof, spring-loaded wheel encoder with a 5 m cable.
- Six 90° probe holder brackets.
- Six spring-loaded arms (SLA).
- Six TOFD-P/E 31.75 mm yokes.
- Two PA 40 mm x 55 mm yokes.
- Water manifold.
- Irrigation tubing and accessories.

Note: the umbilical cable, probes, and wedges are not included with the scanner.

Specifications

Length in Scan Axis (mm)	Width (mm)	Height (mm)	Weight (kg)
279	413	131	3.2

*Standard inclusions allow for the use of six probes. Optional parts must be purchased in order to use 10 probes.

Motorized One-Axis Scanner

WeldROVER – Weld Inspection



The WeldROVER™ is a perfect addition to the Olympus family of scanners for those customers who require a more stable inspection than that provided by manual scanners, and within a more economical package than that of the high-production zone-discrimination systems typically used in offshore pipeline construction.

The WeldROVER is a simple, industrial-strength, one-axis encoded scanner that provides the customer with a fully mechanized automated data acquisition. It is designed to perform fast and efficient phased array inspections on ferromagnetic piping, or vessel girth welds and long seams with minimum training and setup time. The scanner can be configured with up to six probes for phased array, TOFD, and conventional UT inspection.

The WeldROVER is incredibly easy to use. It is operated by a simple two-button remote control with variable speeds. The scanner interfaces with the OmniScan® or TomoScan FOCUS LT¹ instruments directly without the need for complex software, motion controller electronics, or configuration. The laser guide indicator helps the operator manually adjust the scanner direction using the steering lever. This allows precision data to be acquired without the need for guide bands, complex tracking systems, or motorized steering capability. It is a perfect fit for companies offering fully mechanized, automated phased array (AUT) inspection services, and requires less than one hour of training for those customers who have completed the basic OmniScan course.

1 Interface with TomoScan FOCUS LT™ can be achieved using the optional encoder cable adaptor.

Configurations

A typical configuration for compliance with ASME codes is two PA probes, and one or two pairs of TOFD probes.

Circumferential scan

- Supports two probes at the back and two probes at the front of the scanner on pipes from 4 in. OD, and greater.
- Supports up to four probes at the front of the scanner on pipes from 12 in. OD, and greater.
- Supports up to six probes at the front of the scanner on pipes from 16 in. OD, and greater.

Longitudinal scan

- Supports up to six probes at the front of the scanner on pipes from 30 in. OD, and greater.

Note that on smaller pipes, the probe separation distance will be limited.

Features

- Can support up to six probes for TOFD, phased array, or pulse-echo inspections.
- Constant scanning speed control for smooth data acquisition at any speed.
- Compact motion controller offering 10 different scan speeds from 5 mm/s to 50 mm/s.
- Simple two-button remote control for jog or constant encoded motion in either the backwards or forward direction.
- Performs data acquisition using the OmniScan or TomoScan FOCUS LT¹ instrumentation with less than five minutes configuration time.
- The four industrial-strength magnetic wheels are driven for use on ferromagnetic surfaces.
- Integrated water manifold for simple and efficient couplant delivery.
- Emergency-stop button located on the scanner.
- A laser guide indicator to help the operator follow the weld centerline, or any other inspection reference.
- Room to integrate a remote pulser/preamplifier for improved TOFD-P/E inspections.
- Divisible cable conduit umbilical offers cable protection and configuration flexibility. Minimal time needed for probe reconfiguration.
- Waterproof (IP65).

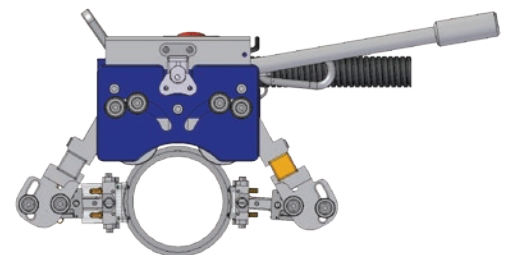

Supports two probes at the back and two probes at the front of the scanner on pipes from 4 in. OD, and greater.

Standard inclusions

- One motorized scanner with rotating probe-holder arms at the front and back of the scanner.
- Two probe holder frame bars of 200 mm (8 in.) and one of 430 mm (17 in)
- Remote control with a 5 m cable.
- MCDC-01: one-axis DC motion controller.
- Power supply.
- Encoder cables linking the MCDC-01 to the OmniScan® MX2 or SX.
- Six spring-loaded arms (SLA), pivoting probe holders, and all the brackets needed for the different configurations.
- Four TOFD-P/E 31.75 mm yokes.
- Two PA 40 mm × 55 mm yokes.
- Two PA 40 mm × 65 mm yokes for PWZ1 and A14 probes.
- Two PA 40 mm × 46 mm yokes.
- Laser guide and holder.

- Two steering levers.
- One 5 m divisible conduit for cable protection and attachment to the scanner.
- Irrigation tubing and fittings.
- Scanner and accessory carrying case.

Note: All cables for scanner operation are 5 m. Probes and wedges are not included with the scanner. The WeldROVER can also be optionally delivered with 10 m cables.

Options

Couplant-Feed Units

See the accessories section on page 25.

Remote Pulser/Preamplifier

See the accessories section on page 26.

Extra Spring-Loaded Probe Holder

P/N: WELDROVER-A-SLA [U8775125]

Extra Laser Guide

P/N: WELDROVER-A-LASER [U8775124]

Instrument case

Modular instrument and accessory hard carrying case. The modules can be used to transform the scanner case into a workstation.

P/N: WELDROVER-A-ICASE [U8775123]

Yokes

See the accessories section on page 31.

Spare Parts Kit

Basic spare part kit for the WeldROVER Scanner.

P/N: WeldROVER-A-SPKit [U8775122]

P/N: WeldROVER-A-SPKit-10M [U8775149]

Data acquisition can be handled completely by the OmniScan MX2 (not included in WeldROVER package)

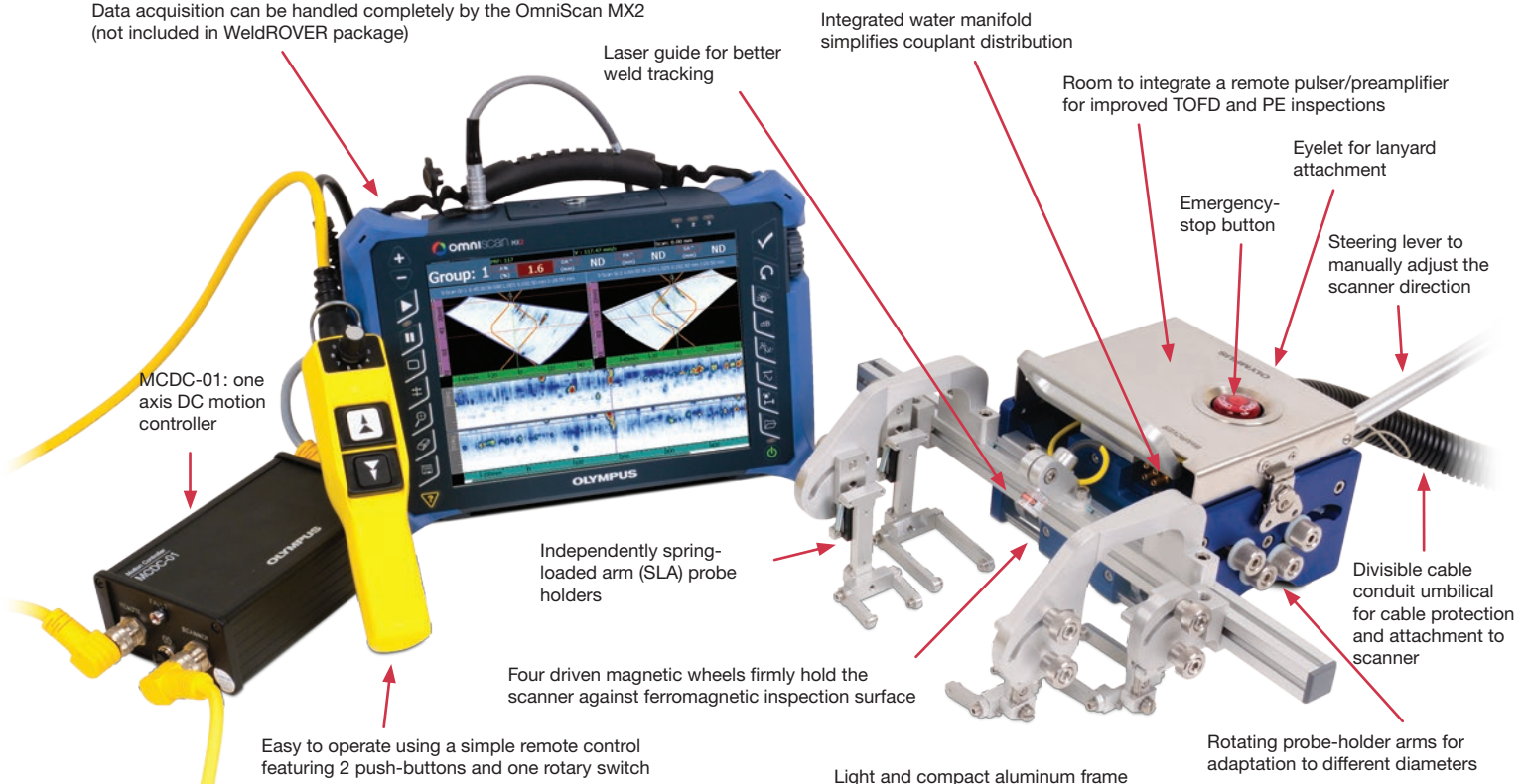

Specifications

Scanner speed: 5 mm to 50 mm per second

Encoder resolution: 2100 steps/mm (typical)

Power consumption: 90 W

Maximum input current: 4 A

Voltage: 24 VDC

Power supply input voltage:
100 VAC to 240 VAC; autoswitching

Component	Length (mm)	Width (mm)	Height (mm)	Weight (kg)
Scanner with long bar and six probes	430	380	175	12.0
Scanner with small bars and four probes	380	200	175	11.0
MCDC-01 motion controller	175	110	60	1.5
Power supply	200	85	50	1.0
Remote control	230	50	90	0.8

Manual Two-Axis Scanner

CHAIN Scanner - Pipe Inspection



The CHAIN™ Scanner is the optimum two-encoded axes manual pipe-inspection solution for a pipe range with outside diameters from 1.75 in. to 38 in. (45 mm to 965 mm). The scanner, which is held by chain links instead of magnetic wheels, is capable of inspecting ferromagnetic or non-ferromagnetic surfaces. The chain links also help ensure a straight displacement of the scanner by eliminating steering problems. It is also very useful when the area around the pipe is not entirely accessible, as the scanner can be rotated by pulling on the chain links.

Main applications

- Circumferential-pipe weld inspections with phased array, TOFD, or conventional UT (picture above)
- Corrosion mapping in conjunction with HydroFORM phased array solution (picture below).



Features

- Standard configuration using one or two probes, and optional configuration using four probes for TOFD, phased array, or pulse-echo inspections.
- A pipe range with outside diameters from 1.75 in. to 38 in. (45 mm to 965 mm).
- An encoded manual scan with up to two axes.
- Ergonomic handle to protect encoder connectors and provide cable management.
- Independent chain links which are mounted on bearing wheels coated with urethane for smooth rolling.
- An easy clamping device for quick scanner positioning.
- Spring-loaded probe holders that ensure good probe contact in any scanner position or orientation.
- The majority of adjustments can be made without the use of tools.

Standard Inclusions

- Main module with a scan-axis encoder.
- Encoded probe-positioning system with lead screw adjustment.
- Chain links for up to 38 in. pipe ODs, with a quick-release adjustable buckle.
- One 5 m encoder cable.
- One 450 mm (17.7 in.) probe-holder bar.
- Two spring-loaded probe holders with two adjustable PA yokes.
- Two adjustable TOFD-P/E yokes.
- One 5 m divisible cable conduit (19 mm ID).
- Cable conduit attachment fixture.
- Irrigation tubes and fittings.
- A CHAIN Scanner custom tool.
- A carrying case.

Note: probes and wedges are not included with the scanner.

Main Module Specifications

Length in Scan Axis (mm)	Width (mm)	Height (mm)	Weight (kg)
114	75	84	1

Encoder resolution:

Circumferential (X) axis: 19.2 steps/mm.
Longitudinal (Y) axis: 226.8 steps/mm.

Options

Remote Pulser/Preamplifier

See the accessories section on page 26.

Couplant-Feed Units

See the accessories section on page 25.

Arm Stabilizer

CHAIN Scanner arm stabilizer kit. Includes a magnetic wheel block and the holder.

P/N: ChainScan-A-Stabilizer [U8775210]

Chain Links

Extra CHAIN Scanner short link. Required on pipe ODs less than 9.6 in.

P/N: ChainScan-A-SLink [U8775127]

Extra CHAIN Scanner long link. To be used on pipe ODs greater than 9.6 in.

P/N: ChainScan-A-LgLink [U8750042]



Additional Packages

Two Additional Probe Package

Needed to perform inspections with four probes and a preamplifier on the CHAIN Scanner.

P/N: ChainScan-A-4Probe [U8775128]

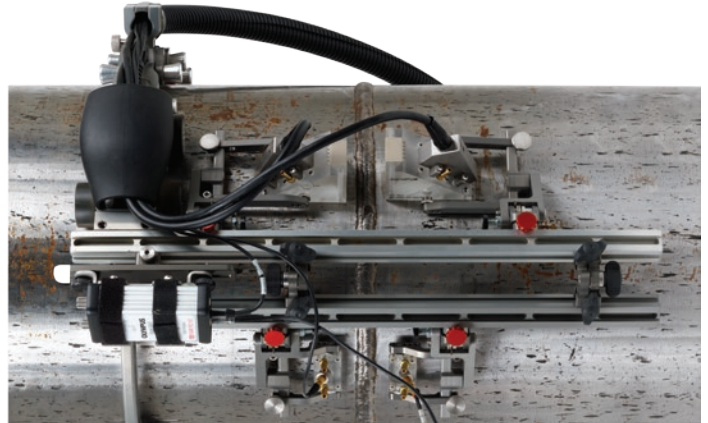

Mouse Package

Needed to use the CHAIN Scanner as a mouse scanner with magnetic wheels holding the system instead of chain links.

P/N: ChainScan-A-Mouse [U8750037]

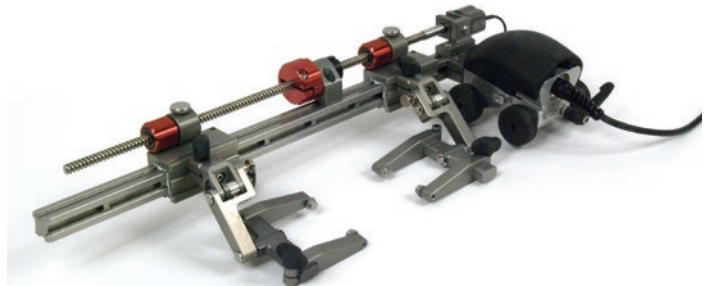

Short Bar Package

A 20 cm probe-holder bar and lead screw kit for restricted space applications.

P/N: ChainScan-A-SBar [U8775129]

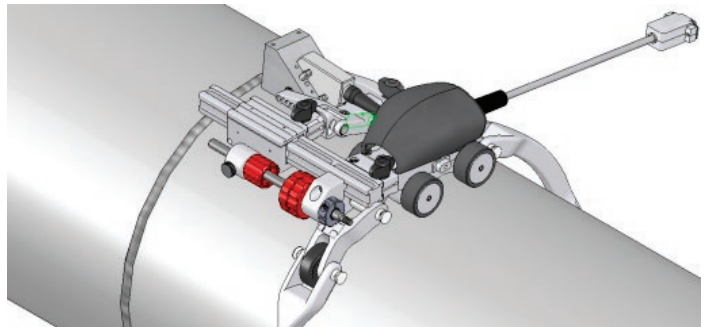

Ordering information

Part Number	Item Number	Description
ChainScan-XY38	U8750041	CHAIN Scanner for 45 mm to 965 mm (1.75 in. to 38 in.) OD pipes with two encoded axes.
ChainScan-SP-Basic	U8779370	Basic spare part kit for the CHAIN Scanner which includes: lead screw and lever for buckle, wedge pivot buttons, dovetail nuts, tool, plastic wheel, and screws.

GLIDER – Composites Inspection



Photo used with the permission of Avior, Produits Intégrés

The GLIDER™ X-Y scanner is a two-axis encoding scanner for manual inspection of slightly curved or flat composite surfaces.

The scanner is well-suited to raster scanning with the following technologies:

- Conventional ultrasonics (UT)
- Phased array ultrasonics (PA)
- Eddy current (EC)
- Eddy current array (ECA)

Commonly inspected materials include composites and aluminum using suction-cup pods, and carbon steel using optional magnetic pods.

Applications

- Inspection of composites.
- Inspection of airplane fuselages for delamination and cracking.
- Inspection of ferromagnetic plates for corrosion.
- Inspection of friction stir welds (FSW) on aluminum.

Design Characteristics

The X axis is attached to two mounting pods. Depending on the material to be inspected, either of the following models can be used:

- Suction-cup mounting pod (included).
- Magnetic mounting pod (optional).

There are two encoder modules (one on each axis) to report the probe position. The displacement of these modules can be in 3.27 mm steps, free running, or locked.

The scanner comes in three formats (18 in., 24 in., and 36 in.), depending on the scan coverage needed:

- GLIDER 18×18
- GLIDER 24×24
- GLIDER 36×36

Features

- Well-suited to phased array UT, conventional UT, and eddy current inspection techniques using one probe.
- Two axes with waterproof encoders for position-encoded X-Y scans.
- Axis positioning with minimal backlash.
- Both modules are mounted on bearings for precise and smooth displacement.
- Two pivot-equipped mounting pods enable surface following.
- Locking devices enable each axis to be locked.
- Module displacement can be in increments of 3.27 mm, or in free-running mode.
- The probe holder is mounted on a bearing-arm system that can be spring loaded if needed.
- An aluminum frame is used for lightweight and rust-free components.
- The Y axis can be easily shortened for smaller surface radius inspection, or removed for easier transport.

Standard Inclusions

- Two tracks for desired stroke (18 in., 24 in., or 36 in., depending on the model).
- Two displacement-encoding modules.
- Two suction-cup mounting pods.
- Two encoders with a 5 m cable.
- One PA 40 mm × 55 mm yoke.
- One TOFD-P/E 31.75 mm yoke.
- 90° probe holder mounting bracket.
- 180° probe holder mounting bracket.
- 45°, 90°, 180° adjustable probe holder mounting bracket.
- Probe holder bearing arm with spring.
- Irrigation tubing and fitting.
- A carrying case.

Note: the umbilical cable, probes, and wedges are not included with the scanner.

Specifications

Weight: 5 kg to 8 kg, depending on the configuration

Suction-cup pod holding force: 7 kg per cup

Magnetic-pod holding force: 81 kg per base

Encoder resolution: 13 steps/mm (± 0.15 step/mm), 330 steps/in. (± 0.006 step/in.)

Minimum curvature for partial scans: 50 cm (20 in.) OD

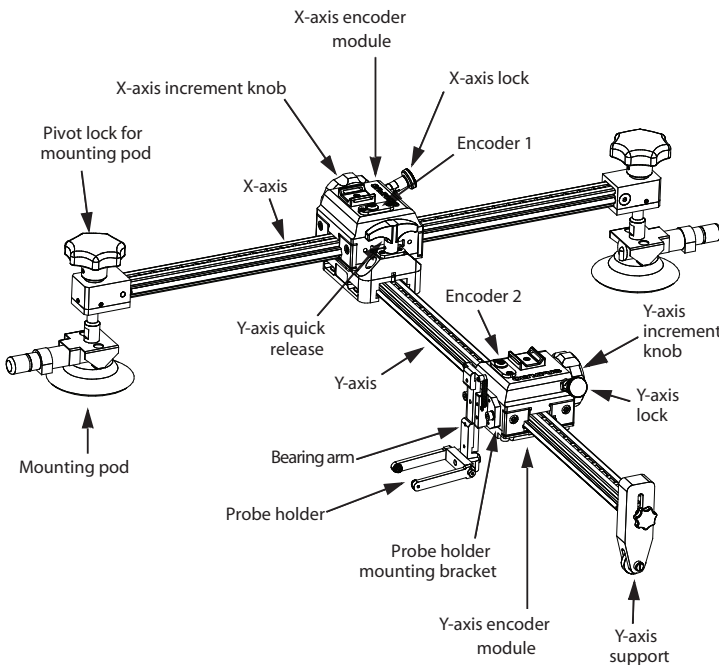

Options

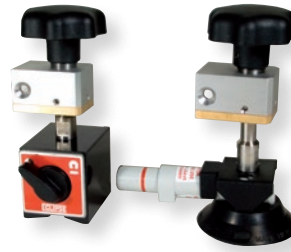

Interchangeable mounting pods (magnetic pods are optional).

Magnetic accessories package

Magnetic mounting pods and Y-axis support enable use on ferromagnetic surfaces.

P/N: GLIDER-A-01 [U8775058]

Tracks

457 mm, 610 mm, or 914 mm (18 in., 24 in., or 36 in.) tracks are available as options.

Stroke mm (in.)	Part Number [Item Number]	
	X Axis	Y Axis
457 (18)	GLIDER-A-X18 [U8775059]	GLIDER-A-Y18 [U8775062]
610 (24)	GLIDER-A-X24 [U8775060]	GLIDER-A-Y24 [U8775063]
914 (36)	GLIDER-A-X36 [U8775061]	GLIDER-A-Y36 [U8775064]

Encoder cables

Y-Axis Stroke mm (in.)	Part Number	Item Number
457 (18)	GLIDER-A-18X18- Lcable-5M	U8775302
610 (24)	GLIDER-A-24X24- Lcable-5M	U8775303
914 (36)	GLIDER-A-36X36- Lcable-5M	U8775304

Note: if the scanner is modified with a longer Y-axis track than the original one, the encoder cable must also be changed in order to benefit from the maximum stroke.

Yokes

See the accessories section on page 31 .

Couplant-Feed Units

See the accessories section on page 25.

Ordering Information

Part Number	Item Number	Description	Length (X) (mm)	Width (Y) (mm)	Height (mm)
GLIDER-18X18	U8750001	GLIDER scanner with X-Y 457 mm × 457 mm stroke (18 in. × 18 in.)	700	690	152
GLIDER-24X24	U8750002	GLIDER scanner with X-Y 610 mm × 610 mm stroke (24 in. × 24 in.)	900	845	152
GLIDER-36X36	U8750003	GLIDER scanner with X-Y 914 mm × 914 mm stroke (36 in. × 36 in.)	1200	1150	152

WING Scanner – Composite Inspection of Curved Surfaces



The WING™ Scanner is a two-axis scanner for manual ultrasonic inspections. One scanning axis is flexible and conforms to the contour of the part being inspected. Vacuum cups make the WING Scanner well-suited for non-ferromagnetic surface inspections.

Typical applications include the inspection of friction stir welding (FSW), and the inspection to detect delamination, cracks, and corrosion on plates and airplane fuselage.

Specifications and ordering information

Specifications	Part Number [Item Number]	Wing-Scanner-V1 [U8750016]	Wing-Scanner-V2 [U8750030]	Wing-Scanner-H1 [U8750031]
X-axis stroke (mm)		940	1940	940
Y-axis stroke (mm)		510	510	510
Vacuum generation*		Venturi with air supply	Venturi with air supply	Manually activated levers
Minimum external radius (mm)		360	380	450
Minimum internal radius (mm)		770	770	770
Holding force (kg/cup)		30	30	11
Number of cups		10	19	8
Total weight (kg)		6.3	8.8	7.0
Overall scanner length (X axis) (mm)		1395	2395	1120
Overall scanner length (Y axis) (mm)		790	790	790
Total height (mm)		157	157	165

* For “V” models, compressed-air characteristics must correspond to the following specifications:
Required pressure: 490 kPa to 690 kPa (71 psi to 100 psi).
Flow rate: 566 nl/min (20 SCFM) minimum.

Features

- Two encoded axes for X-Y scans.
- Axis positioning with minimal backlash.
- Vacuum cups mounted on the flexible axis ease installation on both concave and convex non-ferromagnetic surfaces.
- Scanner can be used vertically or upside down using Venturi vacuum cups (WING Scanner “V” models only).
- Suitable for phased array and conventional UT inspection techniques using one probe.
- Also available in a manually activated vacuum-cup version suited for smooth surfaces. This system eliminates the need for supply (WING Scanner H1 model).

NOTE: the scanner must always be secured with a lanyard when used on vertical or upside down surfaces.

Flexible X axis

- Very flexible contour-following track.
- Multiple vacuum cups.
- The encoder module follows the flexible track (resolution: 20.5 steps/mm).
- A locking lever on the encoder module.
- An integrated loop on one end to secure the scanner from accidental falls.

Rigid Y axis

- A 16 mm diameter hard-anodized aluminum shaft with a stainless steel toothed rack.
- The shaft is mounted on a pivot, allowing constant contact between probe and part.
- The shaft does not move under its own weight when the indexing dial is engaged.
- A fully adjustable and tool-free probe-alignment device.
- Indexing increments: 0.5 mm and 1 mm.
- An axis-locking thumb screw.

Standard inclusions

- Two integrated encoders for X and Y axes.
- One 5 m encoder cable compatible with the TomoScan FOCUS LT™ and OmniScan® MX2 or SX using the supplied adaptor.
- Adjustable probe holder.
- One PA 40 mm × 55 mm yoke.
- One TOFD-P/E 31.75 mm yoke.
- Irrigation tubing and fitting.
- A transport case.

Note: the umbilical cable, probes, and wedges are not included with the scanner.

Options

Couplant-Feed Units

See the accessories section on page 25.

Couplant-Feed Units

CFU03 and CFU05 – Electric Couplant-Feed Units



CFU05

CFU03

The CFU03 and CFU05 are portable electric-pump units used to supply couplant to wedges during ultrasonic inspections. Both units are equipped with a diaphragm pump equipped with a bypass to ensure a constant flow and avoid any pump priming issues. The pump units are also equipped with a valve to control the outlet flow. The CFU05 features water-suction capabilities to reduce water loss when used with certain water delay line wedges.

CFU03 Features

- A diaphragm pump with a flow of 3.78 l/min (1 GPM) at 60 psi.
- An internal bypass which ensures that the pump is always primed.
- Operates on 100 VAC and 240 VAC.
- Start/Stop button.
- An outlet flow control valve.
- A pump inlet tube equipped with a filter and check valve to ensure that the tube is always filled.
- Inlet and outlet quick-connect fittings.
- A rugged plastic case.
- CE certified.

CFU05 Features

The CFU05 has the same features as the CFU03, plus:

- Water suction generated by a Venturi system using an external compressed-air supply.

Standard Inclusions

- 3.3 m (10 ft), 9.5 mm (3/8 in.) ID tube for pump inlet with filter and check valve.
- 3.3 m (10 ft), 9.5 mm (3/8 in.) ID tube for vacuum outlet (CFU05 only).
- 3.3 m (10 ft), 5 mm (3/16 in.) ID tube and Y adaptor for pump outlet.
- 3.3 m (10 ft), 5 mm (3/16 in.) ID tube and Y adaptor for vacuum inlet (CFU05 only).
- Power supply, 100 VAC to 240 VAC input to 24 VDC output.

Manual Couplant-Feed Units

The manual-pump unit offers an affordable and efficient way to supply couplant to wedges during automated inspections.

Features

- Reservoir capacity of 4 L or 8 L
- Flow valve
- Supplied tubes: 8 mm OD and 5 mm ID
- Sling for easy transport

Ordering Information



WTR-SPRAYER-8L

Part Number	Item Number	Description
CFU03	U8780008	Electric couplant-feed unit.
CFU05	U8780009	Electric couplant-feed unit with suction capability.
WTR-SPRAYER-4L	U8775153	4 L manual water pump with irrigation tubes and fittings.
WTR-SPRAYER-8L	U8775001	8 L manual water pump with irrigation tubes and fittings.

Pulsers and Preamplifiers

TRPP 5810 – Pulsar/Preamplifier for TOFD Inspection



The TRPP 5810™ unit is a high-performance remote pulser/preamplifier dedicated to TOFD inspections and compatible with the Olympus scanner line, in addition to the PV-100 and PV-200 weld-inspection systems.

This remote pulser/preamplifier provides an optimum signal-to-noise ratio for TOFD inspections by combining a 40 dB preamplifier with a remote high-voltage (200 V) pulse repeater in a single, small enclosure. The TRPP 5810 supports two UT channels, which enables simultaneous inspection with one or two pairs of TOFD probes.

The TRPP 5810 can be used as a pulser and/or preamplifier.

TRPP 5810 as a Pulsar

- Provides an additional pulse gain to generate a stronger signal, as needed in order to reveal difficult-to-detect flaws.

TRPP 5810 as a Preamplifier

- Provides the additional gain or broadband signal-to-noise enhancement necessary for optimum signal acquisition on thick sections of material exhibiting high ultrasonic attenuation.
- Allows long cables to be driven from remotely located sensors.

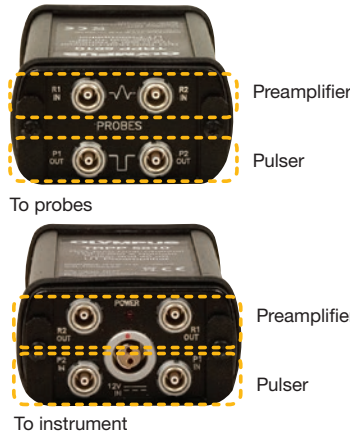

Features

- Dimensions (W × H × L): 57 mm × 32 mm × 90 mm.
- Weight: 300 g.
- UT connectors: 8 × LEMO 00 female.
- Water/moisture resistance: NEMA 4-IP66. Rustproof.
- Powered by an external 12 VDC source, or from the instrument.
- Power connector: Compatible with standard Olympus umbilical cables (male Fisher 103 type).
- A red power-on LED indicator.
- Operating temperature range: -10°C to 60°C.

Specifications

Pulsar

- A remote, high-voltage (200 V) pulse repeater.
- PRF of up to 10 kHz at 100 ns per channel, and up to 20 kHz at 50 ns for a single channel.
- Pulsar-side outputs which protect against misuse and improper connection from the instrument outputs.

Preamplifier (Receiver)

- 40 dB preamplifier.
- Accommodates probe frequency ranges from 1 MHz to 15 MHz.
- Preamplifier side inputs and outputs are protected against misuse and improper connection from the instrument outputs.

Options

Power Cable (from TomoScan FOCUS LT)

One 5 m power supply cable linking to the TomoScan FOCUS LT™.

P/N: TRPP-5810-A-01 [U8800488]

Power Cable (from OmniScan)

10 m power supply cable linking to the OmniScan®.

P/N: TRPP-A-PWRC-OM-10M [U8775118]

Transformer and Cable

Transformer (120 VAC to 240 VAC input to 12 VDC output) with a 10 m power supply cable.

P/N: TRPP-A-PWRC-AC-10M [U8779168]

Ordering Information

Part Number	Item Number	Package Contents
TRPP-5810	U8120042	Pulsar/Preamplifier, one 5 m power supply cable (120 VAC to 240 VAC input to 12 VDC output), and one 5 m power supply cable linking to an OmniScan®, and carrying case.
TRPP-5810-KIT01	U8120043	Same as P/N TRPP-5810, plus: Four 0.6 m UT probe cables (LEMO 00 to Microdot), and brackets to attach the TRPP 5810 to HSMT-type scanner. (P/N: HSMT-A-BRK5810 [U8779088])
TRPP-5810-INST	U8775114	Same as P/N TRPP-5810-KIT01, plus: Four 5 m UT cables (LEMO 00 to LEMO 00) linking the TRPP 5810 to the instrument.
TRPP-5810-UMB	U8775113	Same as P/N TRPP-5810-KIT01, plus: Four 0.6 m UT cables (LEMO 00 to LEMO 00) linking the TRPP 5810 to the umbilical.

5682 – Preamplifier for TOFD Inspection

The 5682 ultrasonic preamplifier provides low-noise amplification of ultrasonic signals (for one probe) ranging from 500 kHz to 25 MHz. The preamplifier, which is housed in a rugged splashproof enclosure, is very small and lightweight, making it ideally suited to remote applications. The preamplifier can be powered with either a single 9 V battery (included) for up to 50 hours of continuous operation, or an optional 9 V to 13 V DC supply. When battery operated, a multicolored LED provides battery feedback status. This preamplifier is ideal for TOFD inspections.

Specifications

- 30 dB gain
- 50 hours of battery life (continuous discharge)
- A continuous power-level indicator
- 67 dB signal-to-noise ratio
- Weight: 180 g with battery



5682-KIT01

Ordering Information

Part Number	Item Number	Package Contents
5682	U8120006	5682 preamplifier and 9 V battery.
5682-KIT01	U8120038	5682 preamplifier, one 2.5 m UT probe cable (LEMO 00 to LEMO 00), one 2.5 m power supply cable linking to the OmniScan® and a belt case.
5682-KIT02	U8779091	5682 preamplifier, one 5 m UT probe cable (LEMO 00 to LEMO 00), one 5 m UT probe cable (LEMO 00 to Microdot), one 0.6 m UT probe cable (LEMO 00 to Microdot), one 5 m power supply cable linking to the OmniScan®, a belt case, and a bracket to attach the 5682 to HSMT-type scanners, HST-Lite, or CHAIN Scanner. (P/N: HSMT-A-BRK5682 [U8779089])
5682-A-PWRC-OM-5M	U8775119	One 5 m power supply cable linking to the OmniScan.
5682-A-PWRC-UMB-0.15M	U8779092	Power cable adaptor linking the 5682 preamplifier to the umbilical cable.

PR-06-04 – Pulsar/Preamplifier for Pulse-Echo Inspection

The PR-06-04 is a four-channel pulser/preamplifier for pulse-echo. Each channel can drive a conventional UT probe for a higher gain pulse and boost the return signal, thereby improving detection and signal-to-noise ratio. The PR-06-04 can also be used as a pulser or a receiver only.

Specifications

Pulsar

- -45 V to -220 V input level (min-max)
- -160 V to -190 V output amplitude (pulser at 100 ns)
- 4 ns to 10 ns rise time and fall time

Receiver

- 40 dB gain
- 8 dBm to 12 dBm input level (max.)
- 8 dBm to 12 dBm output level operation
- 550 kHz to 30 MHz bandwidth at -3 dB



Ordering Information

Part Number	Item Number	Package Contents
PR-06-04	U8750028	PR-06-04 pulser/preamplifier.
OPTX667	U8775012	PR-06-04 pulser/preamplifier, four 0.6 m UT probe cables (LEMO 00 to 90° Microdot), and a bracket to attach the unit to an HSMT-type scanner. (P/N: HSMT-A-BRKEX [U8779090])

Note: These packages have been created to be used with an umbilical cable with an integrated power cable. If no such umbilical is used, an optional power cable must be ordered. Due to power requirements, the PR-06-04 cannot be connected to the OmniScan power output.

Options

Transformer and Cable

Transformer (120 VAC to 240 VAC input to 12 VDC output) with a 5 m power supply cable. P/N: TRPP-5810-A-03 [U8800490]

Transformer (120 VAC to 240 VAC input to 12 VDC output) with a 10 m power supply cable. P/N: TRPP-A-PWRC-AC-10M [U8779168]

Cables and Adaptors

Umbilical Cables

Umbilical cables are used to make all the connections between the scanner and the acquisition unit. They can be of two types:

- Closed umbilical
- Divisible conduit

Closed umbilical

The closed-type umbilical offers the best rugged protection. It covers the cable with a resistant, waterproof, and dust proof conduit. It is also always fitted with a safety hook on both ends, and comes in different models according to the applications and scanners with which it is intended to be used. The configuration of the cables is fixed, and cannot be changed afterwards.



Ordering information for Umbilical cables

UMB-UTPA0202-10-RO

Umbilical cable type

UT and PA cables

Cable length

Power cable

Umbilical cable type

UMB1 = Umbilical for HSMT scanners.

UT and PA cable

UT = RG174 coaxial cables for conventional UT probes.

PA0000 = 128-element OmniScan PA probe extension.

PA0202 = 124-element OmniScan PA probe extension with 4 LEMO 00 at pin 63–64 and 127–128.

IBTx = 128-element Interbox with two OmniScan PA probe connectors, TRPP 5810™, and x (0, 4, or 8) extra UT channels.

IBx = 128-element Interbox with two OmniScan PA probe connectors and x (0, 4, or 8) UT channels.

64IBTx = 64-element Interbox with two OmniScan PA probe connectors, TRPP 5810™, and x (0, 4, or 8) extra UT channels.

64IBx = 64-element Interbox with two OmniScan PA probe connectors, and x (0, 4, or 8) UT channels.

Cable length in meter*

5 = 5 m

10 = 10 m

Power cable

RO = Remote pulser/receiver or Interbox power cable linking to OmniScan® or AC-using adaptor.

*Can be customized, common values shown. Note that, under certain circumstances, the use of longer phased array cables can lead to signal degradation due to attenuation and/or crosstalk.







Divisible conduit

The divisible type is composed of two split shells that completely protect the cables. Even though it is not as rugged as the closed-type umbilical, it offers other advantages. Because the cables can be changed inside at any time, there is no need for connection boxes, which are often needed for PA probes on the scanners. The probes must have the proper cable length to reach the acquisition unit.

Ordering information

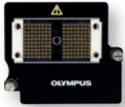
Part Number	Item Number	Description
60BA5028	U8779093	One 0.3 m divisible cable conduit with a 16 mm ID. Well-suited to 2 × PA, irrigation tube, and the encoder cable.
60BA0109	U8779094	One 0.3 m divisible cable conduit with a 19.2 mm ID. Well-suited to 2 × PA, 2 × conventional UT, irrigation tube, and the encoder cable. Standard equipment of HydroFORM™ scanner.
60BA0131	U8775093	One 0.3 m divisible cable conduit with a 24.2 mm ID. Well-suited to 2 × PA, 4 × conventional UT, irrigation tube, encoder, and preamplifier power supply cables.
OPTX0719	U8779095	One 5 m divisible cable conduit with 24.2 mm ID. Well-suited to 2 × PA, 4 × conventional UT, irrigation tube, encoder, and preamplifier power supply cables. Standard equipment of WeldROVER™ scanner.

Adaptors and Extension Cables

Part Number	Item Number		Description
ADAPTORS			
OMNI-A2-ADP03	U8775202		Adaptor for Hypertronics PA probe to instrument with an OmniScan connector. Compatible with OmniScan MX2, OmniScan MX, and OmniScan SX.
OMNI-A-ADP05*	U8767016		Y adaptor with OmniScan connectors to support two PA probes with a maximum of 64 elements each. Compatible with OmniScan MX. Connector layout: one female output and two male inputs.
OMNI-A2-SPLIT64	U8100135		Y-adaptor (splitter) with OmniScan connectors to support 2 phased array probes. Compatible with OmniScan MX2 with PA2 modules. Part number details SPLIT64: Compatible with 64 elements PA2 modules SPLIT128: Compatible with 128 elements PA2 modules 4UT: Features four Lemo-00 UT connectors
OMNI-A2-SPLIT64-4UT	U8100136		
OMNI-A2-SPLIT128	U8100133		
OMNI-A2-SPLIT128-4UT	U8100134		
OMNI-A-ADP11*	U8767019		Adaptor with LEMO 00 connectors. Enables the use of up to 8 conventional UT probes with an OmniScan MX PA instrument.
OMNI-A-ADP12	U8767020		Adaptor with LEMO 00 connectors. Enables the use of up to 16 conventional UT probes with an OmniScan PA instrument. Supplied with a 1 m cable.

*These adaptors cannot be connected directly to the OmniScan MX2. To make the connection, a PA extension cable is needed (E128P type, shown on table below).

PHASED ARRAY EXTENSION CABLES (COMMON MODELS)

E128P0-0202-OM	U8800635		An extension cable with an OmniScan connector at both ends. Can be fitted with 4 LEMO 00 connectors enabling the simultaneous use of conventional UT and PA probes with a PA instrument. Option: A bracket for mounting the OmniScan PA extension on HSMT scanners. P/N: HSMT-A-BRKEX [U8779090]
E128P5-0004-OM	U8800441		
E128P5-0202-OM	U8800442		
E128P10-0004-OM	U8800431		
E128P10-0202-OM	U8800432		

Combining extension cables with adaptors offers numerous connection possibilities.

Ordering information for PA Extension Cables

E128P10-0202-OM

Number of elements _____ Instrument connector
 Cable type _____ Probe connector
 Cable length _____

Number of elements in extension

128 = 128 elements

Cable type

P = Flexible PVC cable
 M = Metal armor outer cover

Cable length*

0 = 0.5 m
 5 = 5 m
 10 = 10 m

Connector on the probe side*

0000 = OmniScan connector and 0 LEMO
 0004 = OmniScan connector and 4 LEMO at pins 125–128
 0202 = OmniScan connector and 4 LEMO at pins 63–64 and 127–128
 HY = Hypertronics connector

Connector on the instrument side*

OM = OmniScan Connector
 HY = Hypertronics connector

* can be customized, common values shown.

Note: Under certain circumstances, the use of longer phased array cables can lead to signal degradation due to attenuation and/or crosstalk.

Interbox

The Interbox is an ergonomic solution for a common problem associated with scanner accessories and connection buildup. This compact hub can connect two phased array probes, two amplified TOFD channels, in addition to eight conventional UT channels to be driven by a phased array acquisition unit. The Interbox can integrate a PA splitter, a TRPP 5810 TOFD pulser/preamplifier, and up to eight extra conventional UT connections, depending on the configuration.

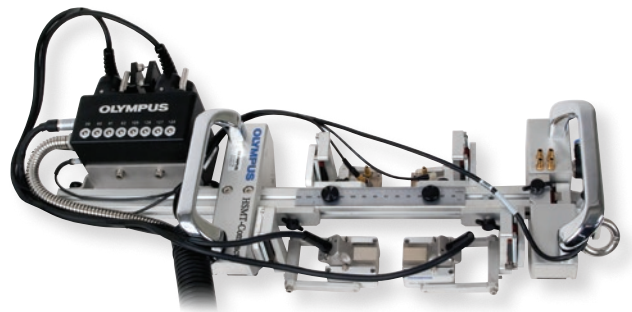

Ordering Information

EIB-T-8-M-5-OM

Extension type Instrument connector
 TRPP 5810 Cable length
 UT connector Cable type

Extension type

IB = Interbox of 128 elements (can connect two PA probes of maximum 64 elements each)
 IB64* = Interbox of 64 elements (can connect two PA probes of maximum 32 elements each)

TRPP 5810™

T = TRPP 5810 included
 NT = TRPP 5810 not included

UT connector

Number of conventional UT connections (LEMO 00)
 0 = Zero connectors
 4 = Four connectors
 8 = Eight connectors

Cable type

P = Flexible PVC cable
 M = Metal armor outer cover

Cable length*

5 = 5 m
 10 = 10 m
 20 = 20 m

Instrument connector*

OM = OmniScan connector
 HY = Hypertronics connector

* can be customized, common values shown.

* Required for OmniScan PA instruments with 64 elements.

Under certain circumstances, the use of longer phased array cables can lead to signal degradation due to attenuation and/or crosstalk.

Yokes

Yokes are used to attach the wedges to the spring-loaded arms (SLA) used on most scanners. Depending on the wedge model used, the yoke model changes. The yokes below are compatible with HSMT scanners, WeldROVER™, WING™ Scanner, and GLIDER™.

Ordering Information

Part Number	Item Number	Wedge compliance	Button OD (mm)	A (mm)	B (mm)
STANDARD YOKES					
ADIX689 ¹	U8775048	ST1, ST2, SPE1, SPE2, SPE3, SA0	5	31.75	23.5
ADIX655 ²	U8775047	SA1, SA2, SA10, SA11, SA12, SPWZ3, SNW1-AQ25 (WR), SNW3-AQ25	8	40	55
OTHER YOKES					
ADIX612	U8775046	SA10 and SA11	8	40	38
ADIX1354	U8775187	SPWZ1 and SA14 (in reverse position)	8	40	46
ADIX1082	U8780194	SPWZ1, SA14, RexoFORM, SNW3-AQ25-WR	8	40	65
ADIX853	U8775055	SA1-L (lateral)	8	45	60
ADIX846	U8779096	SA3	8	50	55
ADIX893	U8775084	SA4, SA5, and HydroFORM-A-LiteHolder	8	55	55
ADIX908	U8779097	Water wedge	8	50	65
ADIX870	U8775056	Creeping wave probe holder (ADIX1129) [U8775080]	5	40	23
ADIX1325	U8775132	SNW1	8	31.75	55
ADIX1482	U8775165	SNW2	8	31.75	23.5
ADIX1481	U8775164	SNW3	8	31.75	65
ADIX1896	Q7750014	SA17-DN	5	50	38
ADIX1897	Q7750015	SA17-N	5	31.75	38

¹ Standard yoke for TOFD-P/E probe mounting.

² Standard yoke for phased array probe mounting.

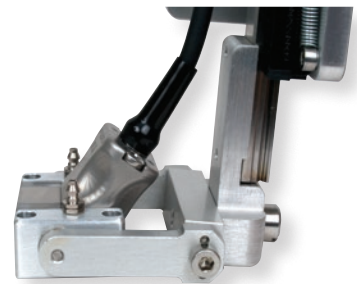
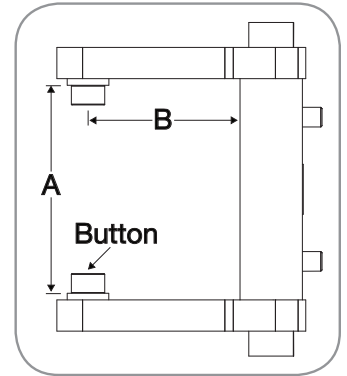

Aqualene Elastomer Couplant

Aqualene™ is an elastomer designed specifically for ultrasonic inspection applications. Acoustic impedance of the material is nearly the same as water, and its attenuation coefficient is lower than many documented elastomers and plastics.

Applications for nondestructive testing include:

- Flexible couplant pads with minimal water addition
- Low-velocity delay lines
- Water-box membrane

Aqualene elastomer couplant reduces the drawbacks of wet coupling when used on porous or refractory surfaces. It allows a minimal amount of couplant to be used while protecting the probe when in direct contact with the part. Furthermore, Aqualene can serve as a thermic insulator. Aqualene couplant products are available in many sizes and thicknesses.

Ordering Information

Part Number	Item Number	Description	Size (L x W x H) mm (in.)
29HD0002	U8770300	Plate	146 × 146 × 2 (5.75 × 5.75 × 0.08)
29HD0004	U8770301	Plate	152 × 152 × 6.4 (6 × 6 × 0.25)
29HD0005	U8770302	Plate	102 × 102 × 25.4 (4 × 4 × 1)
29HD0009	U8770299	Plate	102 × 203 × 2.3 (4 × 8 × 0.09)
29HD0010	U8770303	Plate	200 × 100 × 0.5 (7.9 × 3.9 × 0.02)
29HD0011	U8770304	Plate	127 × 127 × 25.4 (5 × 5 × 1)



How to Order

For pricing or additional information, contact your local sales representative.

To quickly locate your local sales representative, go to www.olympus-ims.com.

Training

Olympus has developed its unique Training Academy, which is a partnership with major training companies, in an effort to offer comprehensive courses in phased array technology and applications. Courses range from a two-day "Introduction to Phased Array" program to an in-depth, two-week "Level II Phased Array" course. In both cases, students experience practical training utilizing the portable OmniScan® phased array unit. Courses lead to either recognized certification or certificates of attendance.

Courses are currently being offered at the training facilities of participating companies, and at customer-determined locations worldwide. Customized courses can also be arranged. Check the latest course schedule in the "Support" section at www.olympus-ims.com.

www.olympus-ims.com

**OLYMPUS SCIENTIFIC SOLUTIONS AMERICAS CORP.
is ISO 9001 and 14001 certified**

*All specifications are subject to change without notice.

All brands are trademarks or registered trademarks of their respective owners and third party entities.
Copyright © 2012 by Olympus.

OLYMPUS®

OLYMPUS SCIENTIFIC SOLUTIONS AMERICAS CORP.

48 Woerd Avenue, Waltham, MA 02453, USA, Tel.: (1) 781-419-3900
12569 Gulf Freeway, Houston, TX 77034, USA, Tel.: (1) 281-922-9300

OLYMPUS NDT CANADA INC.

505, boul. du Parc-Technologique, Québec (Québec) G1P 4S9, Tel.: (1) 418-872-1155
1109 78 Ave, Edmonton (Alberta) T6P 1L8

For enquiries - contact
www.olympus-ims.com/contact-us



Mixed Sources
Products from well-managed
forests, controlled sources and
recycled fibers or fiber
Cert. No. XXXXXXXX
www.fsc.org
© 1996 Forest Stewardship Council